



SDG Series Arbitrary Waveform Generator

Programming Guide

PG02_E05A

Content

1	PROGRAMMING OVERVIEW	7
1.1	BUILD COMMUNICATION VIA VISA	7
1.1.1	<i>Install NI-VISA.....</i>	<i>7</i>
1.1.2	<i>Connect the instrument.....</i>	<i>11</i>
1.2	REMOTE CONTROL	12
1.2.1	<i>User-defined Programming.....</i>	<i>12</i>
1.2.2	<i>Using SCPI via NI-MAX</i>	<i>12</i>
1.2.3	<i>Using SCPI over Telnet.....</i>	<i>12</i>
1.2.4	<i>Using SCPI over Socket.....</i>	<i>14</i>
2	INTRODUCTION TO THE SCPI LANGUAGE	15
2.1	ABOUT COMMANDS & QUERIES	15
2.2	DESCRIPTION.....	15
2.3	USAGE	15
2.4	COMMAND NOTATION	16
2.5	TABLE OF COMMAND & QUERIES	16
3	COMMANDS AND QUERIES.....	19
3.1	IEEE 488.2 COMMON COMMAND INTRODUCTION	19
3.1.1	<i>*IDN.....</i>	<i>19</i>
3.1.2	<i>*OPC</i>	<i>20</i>
3.1.3	<i>*RST.....</i>	<i>21</i>
3.2	COMM_HEADER COMMAND.....	22
3.3	OUTPUT COMMAND.....	23
3.4	BASIC WAVE COMMAND	25
3.5	MODULATE WAVE COMMAND.....	29
3.6	SWEEP WAVE COMMAND.....	34
3.7	BURST WAVE COMMAND	38

3.8	PARAMETER COPY COMMAND	41
3.9	ARBITRARY WAVE COMMAND	42
3.10	SYNC COMMAND.....	45
3.11	EQUAL PHASE COMMAND.....	46
3.12	NUMBER FORMAT COMMAND.....	47
3.13	LANGUAGE COMMAND.....	48
3.14	CONFIGURATION COMMAND	49
3.15	DATE AND TIME COMMAND.....	50
3.16	POWER ON COMMAND	51
3.17	KEY COMMAND	52
3.18	BUZZER COMMAND	52
3.19	SCREEN SAVERCOMMAND	53
3.20	CLOCK SOURCE COMMAND.....	54
3.21	FREQUENCY COUNTER COMMAND.....	55
3.22	COUNTER COMMAND	57
3.22.1	:SENSe:COUNTer:CLEar	60
3.22.2	:SENSe:COUNTer:FREQuency:MEASure[:type].....	60
3.22.3	:SENSe:COUNTer:FREQuency:RFREQuency.....	61
3.22.4	:SENSe:COUNTer:FREQuency?.....	61
3.22.5	:SENSe:COUNTer:FREQuency:SNUMBer?.....	62
3.22.6	:SENSe:COUNTer:FREQuency:FDEVIation?.....	62
3.22.7	:SENSe:COUNTer:FREQuency:MEAN?.....	63
3.22.8	:SENSe:COUNTer:FREQuency:MEAN:FDEVIation?	63
3.22.9	:SENSe:COUNTer:FREQuency:MAX?	64
3.22.10	:SENSe:COUNTer:FREQuency:MAX:FDEVIation?	65
3.22.11	:SENSe:COUNTer:FREQuency:MIN?	65
3.22.12	:SENSe:COUNTer:FREQuency:MIN:FDEVIation?	66
3.22.13	:SENSe:COUNTer:FREQuency:SDEVIation?.....	66
3.22.14	:SENSe:COUNTer:FREQuency:SDEVIation:FDEVIation?	67

3.22.15	:SENSe:COUNTer:FREQuency:PERiod?	67
3.22.16	:SENSe:COUNTer:FREQuency:PERiod:MEAN?	68
3.22.17	:SENSe:COUNTer:FREQuency:PERiod:MAX?	68
3.22.18	:SENSe:COUNTer:FREQuency:PERiod:MIN?	69
3.22.19	:SENSe:COUNTer:FREQuency:PERiod:SDEVIation?	69
3.22.20	:SENSe:COUNTer:FREQuency:DUTY?	70
3.22.21	:SENSe:COUNTer:FREQuency:DUTY:MEAN?	70
3.22.22	:SENSe:COUNTer:FREQuency:DUTY:MAX?	71
3.22.23	:SENSe:COUNTer:FREQuency:DUTY:MIN?	71
3.22.24	:SENSe:COUNTer:FREQuency:DUTY:SDEVIation?	72
3.22.25	:SENSe:COUNTer:TOTalizer:GATE:STATe	72
3.22.26	:SENSe:COUNTer:TOTalizer:EDGE	73
3.22.27	:SENSe:COUNTer:TOTalizer:GATE:MODE	73
3.22.28	:SENSe:COUNTer:TOTalizer:GOLarity:GATE:POLarity	74
3.22.29	:SENSe:COUNTer:TOTalizer:GOLarity:GATE:EDGE	74
3.22.30	:SENSe:COUNTer:TOTalizer?	75
3.23	INVERT COMMAND	76
3.24	DIGITAL FILTER COMMAND	77
3.25	COUPLING COMMAND	78
3.26	OVER-VOLTAGE PROTECTION COMMAND	80
3.27	OVER-CURRENT PROTECTION COMMAND	80
3.28	OVERLOAD STATUS QUERY COMMAND	81
3.29	OUTPUT SKEW	81
3.30	STORE LIST COMMAND	82
3.31	ARB DATA COMMAND	86
3.32	SEQUENCE COMMAND	90
3.32.1	[[:SOURce]:<channel>:ARBMode <Mode>	90
3.32.2	[[:SOURce]:<channel>:SEQuence <switch>	90
3.32.3	[[:SOURce]:<channel>:SEQuence:BURSt <count>	91

3.32.4	<code>[[:SOURCE]:<channel>:SEQUENCE:RMODE <mode></code>	92
3.32.5	<code>[[:SOURCE]:<channel>:TRIGGER[:SEQUENCE]:SOURCE</code>	92
3.32.6	<code>[[:SOURCE]:<channel>:TRIGGER[:SEQUENCE][:IMMEDIATE]</code>	93
3.32.7	<code>[[:SOURCE]:<channel>:TRIGGER:TIMER</code>	93
3.32.8	<code>[[:SOURCE]:<channel>:TRIGGER[:SEQUENCE]:SLOPE</code>	94
3.32.9	<code>[[:SOURCE]:<channel>:SEQUENCE:COUNT</code>	95
3.32.10	<code>[[:SOURCE]:<channel>:SEQUENCE:DEFAULT</code>	95
3.32.11	<code>[[:SOURCE]:<channel>:SEQUENCE:NEW</code>	96
3.32.12	<code>[[:SOURCE]:<channel>:SEQUENCE:SEGMENT<x>:WAVEFORM</code>	96
3.32.13	<code>[[:SOURCE]:<channel>:SEQUENCE:SEGMENT<x>:REPEAT:COUNT</code>	97
3.32.14	<code>[[:SOURCE]:<channel>:SEQUENCE:SEGMENT<x>:AMPLITUDE</code>	98
3.32.15	<code>[[:SOURCE]:<channel>:SEQUENCE:SEGMENT<x>:OFFSET</code>	99
3.32.16	<code>[[:SOURCE]:<channel>:SEQUENCE:SEGMENT<x>:VOLTAGE:HIGH</code>	100
3.32.17	<code>[[:SOURCE]:<channel>:SEQUENCE:SEGMENT<x>:VOLTAGE:LOW</code>	101
3.32.18	<code>[[:SOURCE]:<channel>:SEQUENCE:SEGMENT<x>:LENGTH</code>	102
3.32.19	<code>[[:SOURCE]:<channel>:SEQUENCE:SEGMENT<x>:DELETE</code>	103
3.32.20	<code>[[:SOURCE]:<channel>:SEQUENCE:SEGMENT<x>:INSERT</code>	103
3.32.21	<code>[[:SOURCE]:<channel>:SEQUENCE:STATE</code>	104
3.32.22	<code>[[:SOURCE]:<channel>:SEQUENCE:SCALE</code>	104
3.32.23	<code>[[:SOURCE]:<channel>:SEQUENCE:INCREASING</code>	105
3.32.24	<code>[[:SOURCE]:<channel>:SEQUENCE:DECREASING</code>	106
3.32.25	<code>[[:SOURCE]:<channel>:SEQUENCE:RECALL</code>	107
3.32.26	<code>[[:SOURCE]:<channel>:SEQUENCE:SAVE</code>	107
3.33	<code>[[:SOURCE]:DIGITAL CHANNEL COMMAND</code>	108
3.33.1	<code>DIG:SRATE</code>	108
3.33.2	<code>[[:SOURCE]:DIG:PERIOD</code>	108
3.33.3	<code>[[:SOURCE]:DIG:CHANNEL<x>:STATE</code>	109
3.33.4	<code>[[:SOURCE]:DIG:OUTPUT</code>	109
3.33.5	<code>[[:SOURCE]:DIG:WAVEFORM</code>	110

3.34	VIRTUAL KEY COMMAND.....	112
3.35	IP COMMAND.....	116
3.36	SUBNET MASK COMMAND	117
3.37	GATEWAY COMMAND.....	118
3.38	SAMPLING RATE COMMAND.....	119
3.39	HARMONIC COMMAND.....	120
3.40	WAVEFORM COMBINING COMMAND	121
3.41	MODE SELECT COMMAND	122
3.42	MULTI-DEVICE SYNC.....	123
3.43	IQ COMMANDS.....	123
3.43.1	<i>IQ:WAVeinfo?</i>	124
3.43.2	<i>:IQ:CENTerfreq</i>	124
3.43.3	<i>:IQ:SAMPLerate</i>	125
3.43.4	<i>:IQ:SYMBOLrate</i>	125
3.43.5	<i>:IQ:AMPLitude</i>	126
3.43.6	<i>:IQ:IQADjustment:GAIN</i>	126
3.43.7	<i>:IQ:IQADjustment:IOFFset</i>	127
3.43.8	<i>:IQ:IQADjustment:QOFFset</i>	127
3.43.9	<i>:IQ:IQADjustment:QSKew</i>	128
3.43.10	<i>:IQ:TRIGger:SOURce</i>	128
3.43.11	<i>:IQ:WAVEload:BUILtin</i>	129
3.43.12	<i>:IQ:WAVEload:USERstored</i>	129
3.43.13	<i>:IQ:FrequencySampling</i>	131
3.44	FILE OPERATION COMMANDS	132
3.44.1	<i>MMEMory:DELeTe</i>	132
3.44.2	<i>MMEMory:RDIRECTory</i>	132
3.44.3	<i>MMEMory:MDIRECTory</i>	132
3.44.4	<i>MMEMory:CATalog</i>	133
3.44.5	<i>MMEMory:COPIY</i>	134

3.44.6 *MMEMory:MOVE* 134

4 PROGRAMMING EXAMPLES **135**

4.1 EXAMPLES OF USING VISA 135

 4.1.1 *VC++ Example* 135

 4.1.2 *LabVIEW Example* 153

 4.1.3 *Python Example* 156

4.2 EXAMPLES OF USING SOCKETS 159

 4.2.1 *Python Example* 159

5 INDEX **163**

1 Programming Overview

By using USB and LAN interfaces, in combination with NI-VISA and programming languages, users can remotely control the waveform generator. Through the LAN interface, VXI-11, Sockets, and Telnet protocols can be used to communicate with the instruments. This chapter introduces how to build communication between the instrument and the PC. It also introduces how to configure a system for remote instrument control.

1.1 Build communication via VISA

1.1.1 Install NI-VISA

Before programming, please make sure that you have properly installed the latest version of National Instruments NI-VISA Software.

NI-VISA is a communication library that enables computer communications to instrumentation. There are two available VISA packages: A full version and the Run-Time Engine. The full version includes NI device drivers and a tool named NI MAX; a user interface to control the device. While the drivers and NI MAX can be useful, they are not required for remote control. The Run-Time Engine is a much smaller file and is recommended for remote control.

For convenience, you can obtain the latest version of the NI-VISA run-time engine or the full version from the National Instruments website. The installation process is similar for both versions.

Follow these steps to install NI-VISA (The full version of NI-VISA 5.4 is used in this example):

- a. Download the appropriate version of NI-VISA (the Run-time engine is recommended)
- b. Double click the visa540_full.exe and observe the dialog box as shown below:

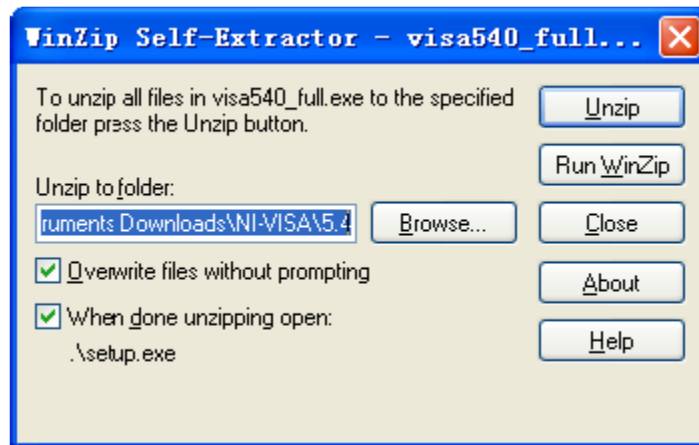

- c. Click Unzip, the install process will launch after unzipping files. If your computer needs to install the .NET Framework 4, it may auto-start.



- d. The NI-VISA install dialog is shown above. Click Next to start the installation process.



- e. Set the install path, the default path is “C:\Program Files\National Instruments\”, you can change it if you prefer. Click Next, dialog as shown above.

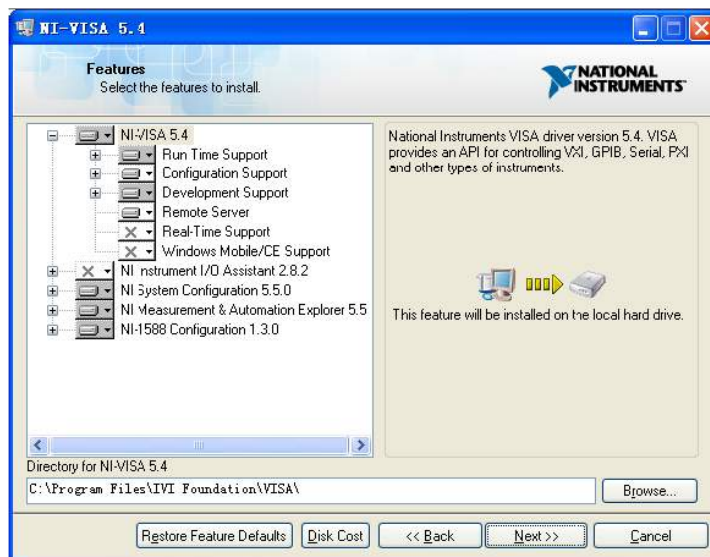

- f. Click Next twice, in the License Agreement dialog, select the “I accept the above 2 License Agreement(s).”, and click Next, and a dialog box will appear as shown below:

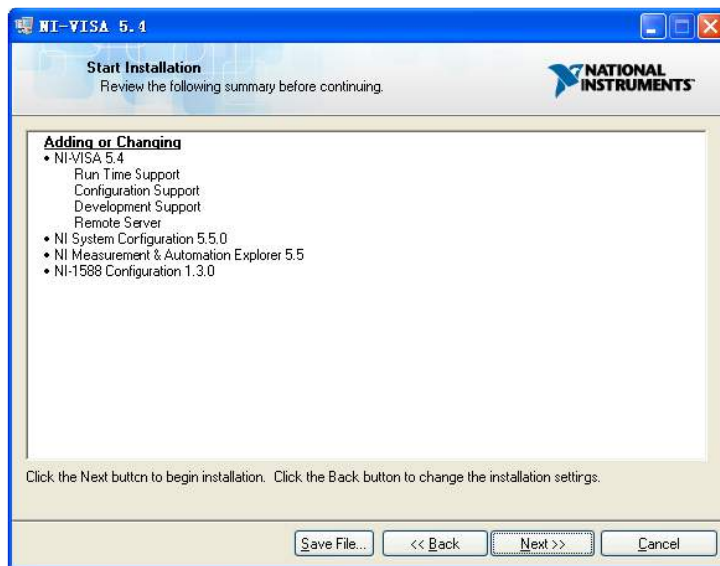

g. Click Next to begin installation.

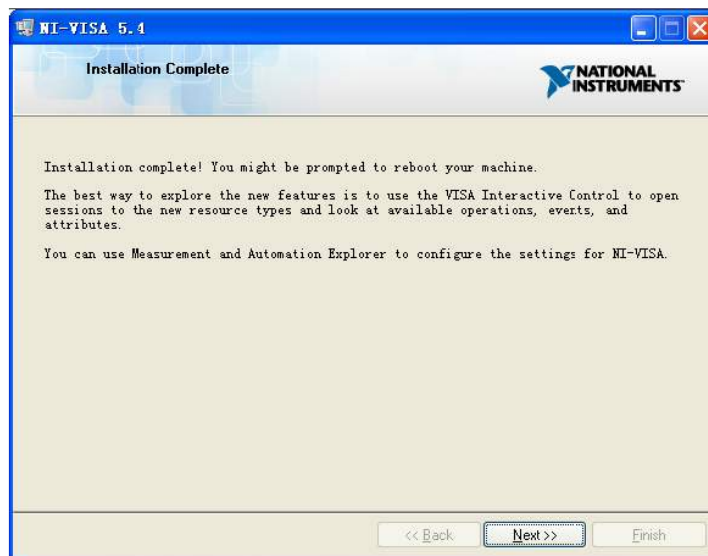

h. Now the installation is complete. Reboot your PC.

1.1.2 Connect the instrument

Depending on the specific model, the arbitrary waveform generator may be able to communicate with a PC through the USB or LAN interface.

Connect the arbitrary waveform generator and the USB Host interface of the PC using a USB cable. Assuming your PC is already turned on, turn on the SDG, and then the PC will display the “Device Setup” screen as it automatically installs the device driver as shown below.

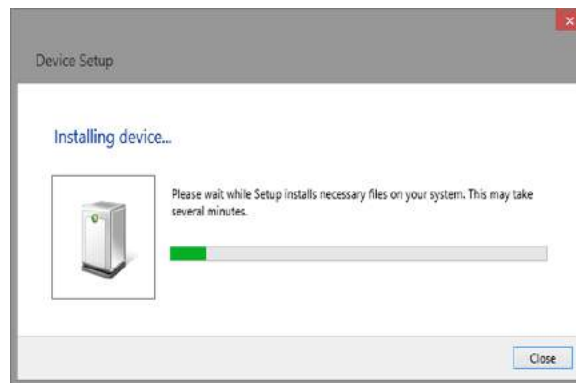

Wait for the installation to complete and then proceed to the next step.

1.2 Remote Control

1.2.1 User-defined Programming

Users can send SCPI commands via a computer to program and control the arbitrary waveform generator. For details, refer to the introductions in "Programming Examples".

1.2.2 Using SCPI via NI-MAX

NI-MAX is a program created and maintained by National Instruments. It provides a basic remote control interface for VXI, LAN, USB, GPIB, and Serial communications. The SDG can be controlled remotely by sending SCPI commands via NI-MAX.

1.2.3 Using SCPI over Telnet

Telnet provides a means of communicating with the SDG over the LAN. The Telnet protocol sends SCPI commands to the SDG from a PC and is similar to communicating with the SDG over USB. It sends and receives information interactively: one command at a time. The Windows operating systems use a command prompt style interface for the Telnet client. The steps are as follows:

1. On your PC, click Start > All Programs > Accessories > Command Prompt.
2. At the command prompt, type in *telnet*.
3. Press the Enter key. The Telnet display screen will be displayed.

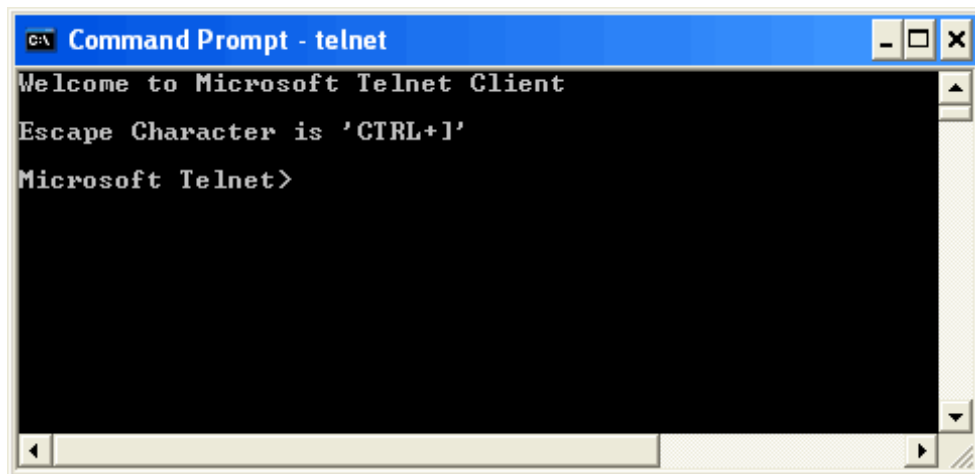

4. At the Telnet command line, type: `open XXX.XXX.XXX.XXX 5024`

Where `XXX.XXX.XXX.XXX` is the instrument's IP address and 5024 is the port. You should see a response similar to the following:

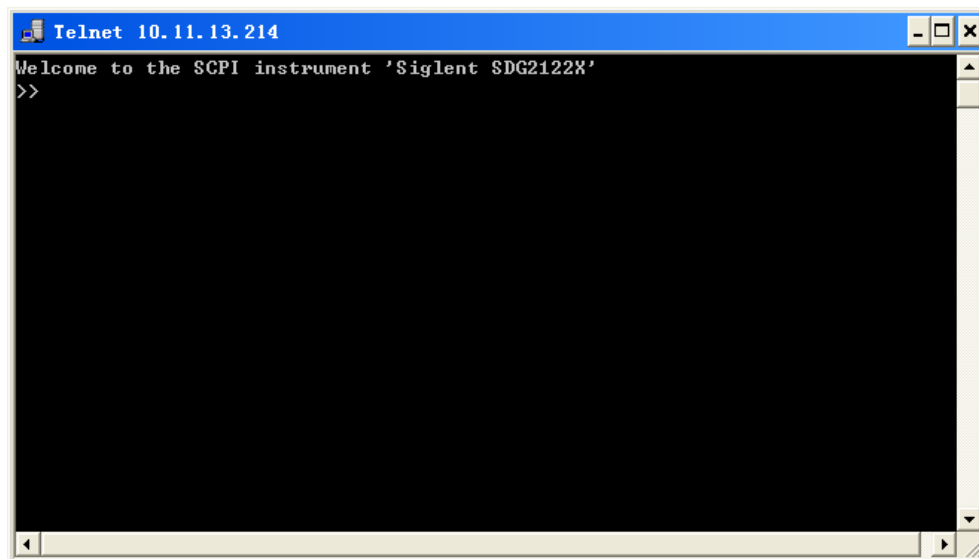

5. At the `SCPI>` prompt, input the SCPI commands such as `*IDN?` to return the company name, model number, serial number, and firmware version number.

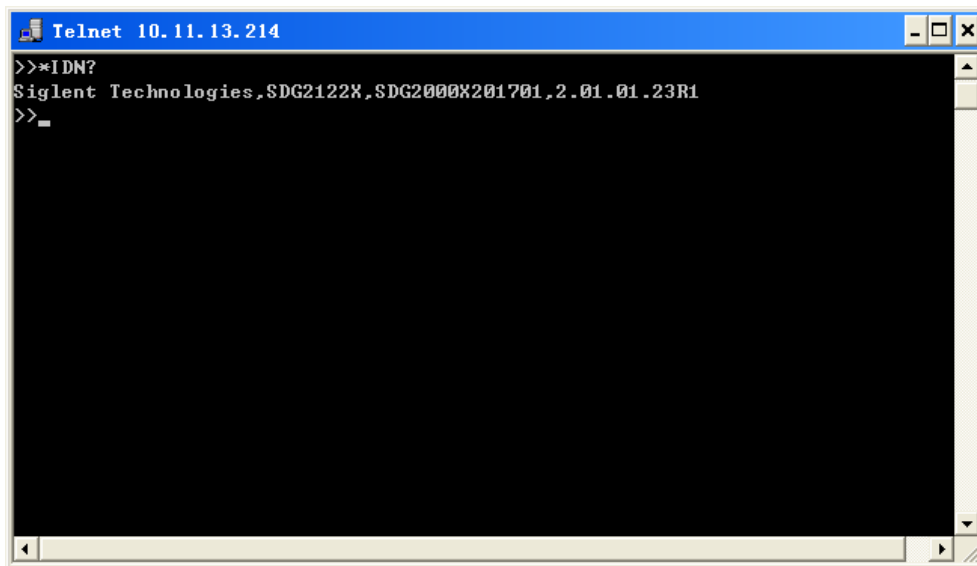

```
Telnet 10.11.13.214
>>*IDN?
Siglent Technologies,SDG2122X,SDG2000X201701,2.01.01.23R1
>>_
```

6. To exit the SCPI> session, press the Ctrl+] keys simultaneously.
7. Type *quit* at the prompt or close the Telnet window to close the connection to the instrument and exit Telnet.

1.2.4 Using SCPI over Socket

Socket API can be used to control the SDG series by LAN without installing any other libraries. This can reduce the complexity of programming.

SOCKET ADDRESS	IP address + port number
IP ADDRESS	SDG IP address
PORT NUMBER	5025

Please see section 4.2 "Examples of Using Sockets" for the details.

2 Introduction to the SCPI Language

2.1 About Commands & Queries

This section lists and describes the remote control commands and queries recognized by the instrument. All commands and queries can be executed in either the local or remote state.

Each command or query, with syntax and other information, has some examples listed. The commands are given in both long and short format at “**COMMAND SYNTAX**” and “**QUERY SYNTAX**”, and the subject is indicated as a command or query or both. Queries perform actions such as obtaining information from the instrument and are identified by a question mark (?) following the header.

2.2 Description

In the description, a brief explanation of the function performed is given. This is followed by a presentation of the formal syntax, with the header given in Upper-and-Lower-Case characters and the short form derived from it in ALL UPPER-CASE characters. Where applicable, the syntax of the query is given with the format of its response.

2.3 Usage

The commands and queries listed here can be used for SDGxxxx Series Arbitrary Waveform Generators.

2.4 Command Notation

The following notations are used in the commands:

< > Angular brackets enclose words that are used as placeholders, of which there are two types: the header path and the data parameter of a command.

:= A colon followed by an equals sign separates a placeholder, from the description of the type and range of values that may be used in a command instead of the placeholder.

{ } Braces enclose a list of choices, one of which must be made.

[] Square brackets enclose optional items.

...] Ellipsis (trailing dots) indicate that the preceding element may be repeated one or more times.

2.5 Table of Command & Queries

Short	Long Form	Subsystem	What Command/Query does
*IDN	*IDN	SYSTEM	Gets identification from device.
*OPC	*OPC	SYSTEM	Gets or sets the OPC bit (0) in the Event Status Register (ESR).
*RST	*RST	SYSTEM	Restore default settings
CHDR	COMM_HEADER	SIGNAL	Sets or gets the command returned format
OUTP	OUTPUT	SIGNAL	Sets or gets the output state.
BSWV	BASIC_WAVE	SIGNAL	Sets or gets the basic wave parameters.
MDWV	MODULATEWAVE	SIGNAL	Sets or gets the modulation parameters.
SWWV	SWEEPWAVE	SIGNAL	Sets or gets the sweep parameters.
BTWV	BURSTWAVE	SIGNAL	Sets or gets the burst parameters.

Short	Long Form	Subsystem	What Command/Query does
PACP	PARACOPY	SIGNAL	Copies parameters from one channel to the other.
ARWV	ARBWAVE	DATA	Changes arbitrary wave type.
SYNC	SYNC	SIGNAL	Sets or gets the synchronization signal.
NBFM	NUMBER_FORMAT	SYSTEM	Sets or gets the data format.
LAGG	LANGUAGE	SYSTEM	Sets or gets the language.
SCFG	SYS_CFG	SYSTEM	Sets or gets the power-on system setting way.
BUZZ	BUZZER	SYSTEM	Sets or gets the buzzer state.
SCSV	SCREEN_SAVE	SYSTEM	Sets or gets the screen save state.
ROSC	ROSCILLATOR	SIGNAL	Sets or gets the state of the clock source.
FCNT	FREQCOUNTER	SIGNAL	Sets or gets the frequency counter parameters.
INVT	INVERT	SIGNAL	Sets or gets the polarity of the current channel.
COUP	COUPLING	SIGNAL	Sets or gets the coupling parameters.
VOLTPRT	VOLTPRT	SYSTEM	Sets or gets the state of over-voltage protection.
STL	STORELIST	SIGNAL	Lists all stored waveforms.
WVDT	WVDT	SIGNAL	Sets and gets the arbitrary wave data.
VKEY	VIRTUALKEY	SYSTEM	Sets the virtual keys.
SYST:COMM:LAN:IPAD	SYSTEM:COMMUNICATE:LAN:IPADDRESS	SYSTEM	The Command can set and get the system IP address.
SYST:COMM:LAN:SMAS	SYSTEM:COMMUNICATE:LAN:SMASK	SYSTEM	The Command can set and get the system subnet mask.
SYST:COMM:LAN:GAT	SYSTEM:COMMUNICATE:LAN:GATEWAY	SYSTEM	The Command can set and get the system Gateway.

Short	Long Form	Subsystem	What Command/Query does
SRATE	SAMPLERATE	SIGNAL	Sets or gets the arbitrary wave mode, sampling rate, and interpolation method.
HARM	HARMonic	SIGNAL	Sets or gets the harmonic information.
CMBN	CoMBiNe	SIGNAL	Sets or gets the wave combine information.
MODE	MODE	SIGNAL	Sets or gets the waveform phase mode
CASCADE	CASCADE	SYSTEM	Set up multi-device synchronization
IQ:CENT	IQ:CENTerfreq	SIGNAL	Sets the I/Q modulator center frequency.
IQ:SAMP	IQ:SAMPlerate	SIGNAL	Sets the I/Q sample rate.
IQ:SYMB	IQ:SYMBolrate	SIGNAL	Sets the I/Q symbol rate.
IQ:AMPL	IQ:AMPLitude	SIGNAL	Sets the I/Q amplitude.
IQ:IQAD:GAIN	IQ:IQADjustment:GAIN	SIGNAL	Adjusts the ratio of I to Q while preserving the composite.
IQ:IQAD:IOFF	IQ:IQADjustment:IOFFset	SIGNAL	Adjusts the I channel offset value.
IQ:IQAD:QOFF	IQ:IQADjustment:QOFFset	SIGNAL	Adjusts the I channel offset value.
IQ:IQAD:QSK	IQ:IQADjustment:QSKew	SIGNAL	Adjusts the phase angle between the I and Q vectors by increasing or decreasing the Q phase angle.
IQ:TRIG:SOUR	IQ:TRIGger:SOURce	SIGNAL	Sets the I/Q trigger source.
IQ:WAVE:BUIL	IQ:WAVEload:BUILtin	SIGNAL	Selects the I/Q wave from the built-in wave list.
IQ:WAVE:USER	IQ:WAVEload:USERstored	SIGNAL	Select the I/Q wave from user stored waveforms.
:IQ:FrequencySampling	:IQ: FrequencySampling	SIGNAL	Sets the I/Q Frequency sampling rate.

3 Commands and Queries

3.1 IEEE 488.2 Common Command Introduction

The IEEE standard defines the common commands used for querying the basic information of the instrument or executing basic operations. These commands usually start with "*" and the length of the keywords of the command is usually 3 characters.

3.1.1 *IDN

DESCRIPTION	The *IDN? query causes the instrument to identify itself. The response is comprised of the manufacturer, model, serial number, and firmware version.
QUERY SYNTAX	*IDN?
RESPONSE FORMAT	<p>Format 1: *IDN, <device id>,<model>,<serial number>,<firmware version>, <hardware version></p> <p>Format 2: <manufacturer>,<model>,<serial number>,<firmware version></p> <p><device id>:= "SDG".</p> <p><manufacturer>:= "Siglent Technologies".</p> <p><model>:= A model identifier less than 14 characters, should not contain the word "MODEL".</p> <p><serial number>:= The serial number.</p> <p><firmware version>:= The firmware version number.</p> <p><hardware version>:= The hardware level field, containing information about all separately revisable subsystems.</p>

EXAMPLE

Reads version information:

**IDN?*

Return:

*Siglent Technologies,SDG6052X, SDG6XBAX1R0034,
6.01.01.28* (It may differ from each version)

Notes:

1. The table below shows the available response format of the command in each SDG series.

Parameter /command	SDG800	SDG1000	SDG2000X	SDG5000	SDG1000X	SDG6000X/X-E	SDG7000A
Response Format	Format1	Format1	Format2	Format1	Format2	Format2	Format2

2. Format of <hardware version>: value1-value2-value3-value4-value5.

value1: PCB version.

value2: Hardware version.

value3: Hardware subversion.

value4: FPGA version.

value5: CPLD version.

3.1.2 *OPC

DESCRIPTION

The *OPC (Operation Complete) command sets the OPC bit (bit 0) in the standard Event Status Register (ESR). This command has no other effect on the operation of the device because the instrument starts parsing a command or query only after it has completely processed the previous command or query. The *OPC? query always responds with the ASCII character 1 because the device only responds to the query when the previous command has been entirely executed.

COMMAND SYNTAX *OPC

QUERY SYNTAX *OPC?

RESPONSE FORMAT Format 1: *OPC 1
 Format 2: 1

Note: The table below shows the available response format of the command in each SDG series.

Parameter /command	SDG800	SDG1000	SDG2000X	SDG5000	SDG1000X	SDG6000X/X-E	SDG7000A
Response Format	Format1	Format1	Format2	Format1	Format2	Format2	Format2

3.1.3 *RST

DESCRIPTION The *RST command initiates a device reset and recalls the default setup.

COMMAND SYNTAX *RST

EXAMPLE This example resets the signal generator to the default setup:

**RST*

3.2 Comm_Header Command

DESCRIPTION This command is used to change the query command returned format. “SHORT” parameter returns short format. “LONG” parameter returns long format. The “OFF” parameter returns nothing.

COMMAND SYNTAX Comm_HeaDeR <parameter>
 <parameter>:= {SHORT, LONG, OFF}.

QUERY SYNTAX Comm_HeaDeR?

RESPONSE FORMAT CHDR <parameter>

EXAMPLE Set query command format to long:

CHDR LONG

Read query command format:

CHDR?

Return:

COMM_HEADER LONG

Note: The table below shows the availability of the command in each SDG series.

Parameter /command	SDG800	SDG1000	SDG2000X	SDG5000	SDG1000X	SDG6000X/X-E	SDG7000A
CHDR	yes	yes	no	yes	no	no	no

3.3 Output Command

DESCRIPTION This command enables or disables the output port(s) at the front panel. The query returns “ON” or “OFF” and “LOAD”, “PLRT”, and “RATIO” parameters.

COMMAND SYNTAX <channel>:OUTPut ON|OFF,LOAD,<load>,PLRT, <polarity>
 <channel>:= {C1, C2}.
 <load>:= {see the note below}. The unit is ohms.
 <polarity>:= {NOR, INVT}, in which NOR refers to normal, and INVT refers to invert.

NoiseSum: to add noise to the channel with specified signal-to-noise ratio.

<channel>:NOISE_ADD STATE,ON|OFF,RATIO,<S/N>.

or

<channel>:NOISE_ADD STATE,ON|OFF,RATIO_DB,<S/N(dB)>.

<S/N>:= {2.1-100000000}.

<S/N (dB)>:= {3.24886-80}.

Max Amplitude Output: to limit the maximum amplitude output.

<channel>:BSWV MAX_OUTPUT_AMP, <Amplitude>

<Amplitude>:= {1-20}, Maximum output amplitude peak-to-peak voltages.

QUERY SYNTAX <channel>:OUTPut?
 <channel>:NOISE_ADD?
 <channel>:BSWV?

RESPONSE FORMAT <channel>:OUTP ON|OFF,LOAD,<load>,PLRT, <polarity>
 <channel>:NOISE_ADDSTATE,ON|OFF,RATIO,<S/N >,
 RATIO_DB,<S/N (dB)>
 <channel>:BSWV
 WVTP,<type>,FRQ,<frequency>,PERI,<period>,AMP,<amplitude>
 ,AMPVRMS,<Amplitude>,MAX_OUTPUT_AMP, OFST, <offset>,

HLEV, <high level>, LLEV, <low level>, PHSE, <phase>

EXAMPLE

Turn on CH1:

C1:OUTP ON

Read CH1 output state:

C1:OUTP?

Return:

C1:OUTP ON,LOAD,HZ,PLRT,NOR

Set the load of CH1 to 50 ohms:

C1:OUTP LOAD,50

Set the load of CH1 to HiZ:

C1:OUTP LOAD,HZ

Set the polarity of CH1 to normal:

C1:OUTP PLRT,NOR

turn on NoiseSum and set the signal-to-noise ratio

C1:NOISE_ADD STATE,ON,RATIO,120

Set the maximum output amplitude

C1:BSWV MAX_OUTPUT_AMP,5

Note: The table below shows the availability of the command in each SDG series.

Parameter /command	SDG800	SDG1000	SDG2000X	SDG5000	SDG1000X	SDG6000X/X-E	SDG7000A
<channel>	no	yes	yes	yes	yes	yes	yes
LOAD	50, HiZ	50~10000, HiZ	50~100000, HiZ	50, HiZ	50~100000, HiZ	50~100000, HiZ	50~100000, HiZ

* "HiZ" refers to High Z.

3.4 Basic Wave Command

DESCRIPTION This command sets or gets the basic wave parameters.

COMMAND SYNTAX <channel>:BaSic_WaVe <parameter>,<value>

<channel>:={C1, C2}.

<parameter>:= {a parameter from the table below}.

<value>:={value of the corresponding parameter}.

Parameters	Value	Description
WVTP	<type>	:= {SINE, SQUARE, RAMP, PULSE, NOISE, ARB, DC, PRBS, IQ}. If the command doesn't set basic waveform type, WVTP will be set to the current waveform.
FRQ	<frequency>	:= frequency. The unit is Hertz "Hz". Refer to the datasheet for the range of valid values. Not valid when WVTP is NOISE or DC.
PERI	<period>	:= period. The unit is seconds "s". Refer to the datasheet for the range of valid values. Not valid when WVTP is NOISE or DC.
AMP	<amplitude>	:= amplitude. The unit is volts, peak-to-peak "Vpp". Refer to the datasheet for the range of valid values. Not valid when WVTP is NOISE or DC.
AMPVRMS	<amplitude>	:= amplitude. The unit is Volts, root-mean-square "Vrms".
AMPDBM	<amplitude>	:= amplitude. The unit is dBm.
OFST	<offset>	:= offset. The unit is volts "V". Refer to the datasheet for the range of valid values. Not valid when WVTP is NOISE.
COM_OFST	<common offset>	:={-1 to 1}.common offset. The unit is volts "V". It can be set only when the channel differential output is on.
SYM	<symmetry>	:= {0 to 100}. Symmetry of RAMP. The unit is "%". Only settable when WVTP is RAMP.
DUTY	<duty>	:= {0 to 100}. Duty cycle. The unit is "%". Value depends on frequency. Only settable when WVTP is SQUARE or PULSE.

PHSE	<phase>	:= {0 to 360}. The unit is "degree". Not valid when WVTP is NOISE, PULSE or DC.
STDEV	<stdev>	:= standard deviation of NOISE. The unit is volts "V". Refer to the datasheet for the range of valid values. Only settable when WVTP is NOISE.
MEAN	<mean>	:= mean of NOISE. The unit is volts "V". Refer to the datasheet for the range of valid values. Only settable when WVTP is NOISE.
WIDTH	<width>	:= positive pulse width. The unit is seconds "s". Refer to the datasheet for the range of valid values. Only settable when WVTP is PULSE.
RISE	<rise>	:= rise time (10%~90%). The unit is seconds "s". Refer to the datasheet for the range of valid values. Only settable when WVTP is PULSE.
FALL	<fall>	:= fall time (90%~10%). The unit is seconds "s". Refer to the datasheet for the range of valid values. Only settable when WVTP is PULSE.
DLY	<delay>	:= waveform delay. The unit is seconds "s". Refer to the datasheet for the range of valid values.
HLEV	<high level>	:= high level. The unit is volts "V". Not valid when WVTP is NOISE or DC.
LLEV	<low level>	:= low level. The unit is volts "V". Not valid when WVTP is NOISE or DC.
BANDSTATE	<bandwidth switch >	:= {ON,OFF}. Only settable when WVTP is NOISE.
BANDWIDTH	<bandwidth value>	:= noise bandwidth. The unit is Hertz "Hz". Refer to the datasheet for the range of valid values. Only settable when WVTP is NOISE.
LENGTH	<prbs length>	:= {3~32}. Actual PRBS length = $2^{\text{LENGTH}} - 1$. Only settable when WVTP is PRBS.
EDGE	<prbs rise/fall>	:= rise/fall time of PRBS. The unit is seconds "s". Refer to the datasheet for the range of valid values. Only settable when WVTP is PRBS.
FORMAT	<output format>	:= {DIFF, SINGLE }. Set channel differential output or single ended output
DIFFSTATE	<prbs differential>	:= {ON, OFF}. State of PRBS differential mode. Only

	switch>	settable when WVTP is PRBS.
BITRATE	<prbs bit rate>	:= PRBS bit rate. The unit is bits-per-second "bps". Refer to the datasheet for the range of valid values. Only settable when WVTP is PRBS.
LOGICLEVEL	<prbs logiclevel rate>	:= { TTL_CMOS, LVTTTL_LVCMOS, ECL, LVPECL, LVDS_CUSTOM (only on SDG7000A) }. Only settable when WVTP is PRBS.

QUERY SYNTAX <channel>: BaSic_WaVe?
 <channel>:= {C1, C2}.

RESPONSE FORMAT <channel>:BSWV <parameter>
 <parameter>:= {All the parameters of the current basic waveform}.

EXAMPLE Change the waveform type of C1 to Ramp:
C1:BSWV WVTP,RAMP

Change the frequency of C1 to 2000 Hz:
C1:BSWV FRQ,2000

Set the amplitude of C1 to 3 Vpp:
C1:BSWV AMP,3

Return parameters of C1 from the device:
C1:BSWV?

Return:
*C1:BSWV WVTP,SINE,FRQ,100HZ,PERI,0.01S,AMP,2V,
 OFST,0V,HLEV,1V,LLEV,-1V,PHSE,0*

Set noise bandwidth of C1 to 100 MHz:
C1:BSWV BANDWIDTH,100E6

or

C1:BSWV BANDWIDTH,100000000

Set output amplitude of C1 to 3dBm :

C1:BSWV AMPDBM,3

Set the logic level of C1 to TTL_CMOS :

C1:BSWV LOGICLEVEL,TTL_CMOS

Notes:

1. The table below shows the availability of some command parameters in each SDG series.

Parameter /command	SDG800	SDG1000	SDG2000X	SDG5000	SDG1000X	SDG6000X	SDG6000X-E	SDG7000A
<channel>	no	yes	yes	yes	yes	yes	yes	yes
RISE	yes	no	yes	yes	yes	yes	yes	yes
FALL	yes	no	yes	yes	yes	yes	yes	yes
DLY	no	yes	yes	yes	yes	yes	yes	yes
BANDSTATE	no	no	yes	no	no	yes	yes	yes
BANDWIDTH	no	no	yes	no	no	yes	yes	yes
LENGTH	no	no	no	no	no	yes	no	yes
EDGE	no	no	no	no	no	yes	no	yes
DIFFSTATE	no	no	no	no	no	yes	no	no
BITRATE	no	no	no	no	no	yes	no	yes
LOGICLEVEL	no	no	no	no	no	yes	no	yes
AMPDBM	no	no	yes	no	yes	yes	yes	yes

2. With SDG1000X models, if Wave Combine is enabled, WVTP cannot be set to SQUARE.

3.5 Modulate Wave Command

DESCRIPTION This command sets or gets the modulation parameters.

COMMAND SYNTAX

```

<channel>:MoDulateWaVe <type>
<channel>:MoDulateWaVe <parameter>,<value>
<channel>:={C1, C2}

<type>:= {AM,DSBAM,FM,PM,PWM,ASK,FSK,PSK}.
<parameter>:= {a parameter from the table below}.
<value>:= {value of the from the table below}.
    
```

Parameters	Value	Description
STATE	<state>	:= {ON, OFF}. Enable or disable modulation. STATE must be set to ON before you set or read other parameters of the modulation.
AM,SRC	<src>	:= {INT, EXT,CH1,CH2}. AM signal source.
AM,MDSP	<mod wave shape>	:= {SINE, SQUARE, TRIANGLE, UPRAMP, DNRAMP, NOISE, ARB}. AM modulation wave. Only settable when SRC is INT.
AM,FRQ	<AM frequency>	:= AM frequency. The unit is Hertz "Hz". Refer to the datasheet for the range of valid values. Only settable when SRC is INT.
AM,DEPTH	<depth>	:= {0 to 120}. AM depth. The unit is "%". Only settable when SRC is INT.
DSBAM,SRC	<src>	:= {INT, EXT}. DSB-AM signal source.
DSBSC,SRC	<src>	= {INT, EXT, CH1,CH2}. DSB-SC signal source. (only SDG7000A)
DSBAM,MDSP	<mod wave shape>	:= {SINE, SQUARE, TRIANGLE, UPRAMP, DNRAMP, NOISE, ARB}. DSB AM modulation wave. Only settable when SRC is INT.
DSBSC,MDSP	<mod wave shape>	:= {SINE, SQUARE, TRIANGLE, UPRAMP, DNRAMP, NOISE, ARB}. DSB-SC modulation wave. Only settable when

		SRC is INT. (only SDG7000A)
DSBAM,FRQ	<DSB-AM frequency>	:= DSB-AM frequency. The unit is Hertz "Hz". Refer to the datasheet for the range of valid values. Only settable when SRC is INT.
DSBSC,FRQ	<DSB-SC frequency>	:= DSB-SC frequency. The unit is Hertz "Hz". Refer to the datasheet for the range of valid values. Only settable when SRC is INT.(only SDG7000A)
FM,SRC	<src>	:= {INT, EXT, CH1,CH2}. FM signal source.
FM,MDSP	<mod wave shape>	:= {SINE, SQUARE, TRIANGLE, UPRAMP, DNRAMP, NOISE, ARB}. FM modulation wave. Only settable when SRC is INT.
FM,FRQ	<FM frequency>	:= FM frequency. The unit is Hertz "Hz". Refer to the datasheet for the range of valid values. Only settable when SRC is INT.
FM,DEVI	<FM frequency deviation >	:= {0 to carrier frequency}. FM frequency deviation. The value depends on the difference between the carrier frequency and the bandwidth frequency. Only settable when the signal source is INT.
PM,SRC,	<src>	:= {INT, EXT, CH1,CH2}. PM signal source.
PM,MDSP	<mod wave shape>	:= {SINE, SQUARE, TRIANGLE, UPRAMP, DNRAMP, NOISE, ARB}. PM modulation wave. Only settable when SRC is INT.
PM,FRQ	<PM frequency>	:= PM frequency. The unit is Hertz "Hz". Refer to the datasheet for the range of valid values. Only settable when SRC is INT.
PM,DEVI	<PM phase offset>	:= {0 to 360}. PM phase deviation. The unit is "degree". Only settable when SRC is INT.
PWM,SRC	<src>	:= {INT, EXT, CH1,CH2}. PWM signal source.
PWM,FRQ	<PWM frequency>	:= PWM frequency. The unit is Hertz "Hz". Refer to the datasheet for the range of valid values. Only settable when SRC is INT.
PWM,DEVI	<PWM dev>	:= Duty cycle deviation. The unit is "%". Value depends on the carrier duty cycle.
PWM,MDSP	<mod wave shape>	:= {SINE, SQUARE, TRIANGLE, UPRAMP,

		DNRAMP, NOISE, ARB}. PWM modulation wave. Only settable when SRC is INT.
ASK,SRC	<src>	:= {INT, EXT}. ASK signal source.
ASK,KFRQ	< key frequency>	:= ASK key frequency. The unit is Hertz "Hz". Refer to the datasheet for the range of valid values. Only settable when SRC is INT.
FSK,SRC	<src>	:= {INT, EXT}. FSK signal source.
FSK,KFRQ	< key frequency>	:= FSK key frequency. The unit is Hertz "Hz". Refer to the datasheet for the range of valid values. Only settable when SRC is INT.
FSK,HFRQ	<FSK_hop_freq>	:= FSK hop frequency. The same with basic wave frequency. The unit is Hertz "Hz". Refer to the datasheet for the range of valid values.
PSK,SRC	<src>	:= {INT, EXT}. PSK signal source.
PSK,KFRQ	< key frequency>	:= PSK key frequency. The unit is Hertz "Hz". Refer to the datasheet for the range of valid values. Only settable when SRC is INT.
CARR,WVTP	<wave type>	:= {SINE, SQUARE, RAMP, ARB, PULSE}. Carrier waveform type.
CARR,FRQ	<frequency>	:= carrier frequency. The unit is Hertz "Hz". Refer to the datasheet for the range of valid values.
CARR,PHSE	<phase>	:= {0 to 360}. Carrier phase. The unit is "degree".
CARR,AMP	<amplitude>	:= carrier amplitude. The unit is volts, peak-to-peak "Vpp". Refer to the datasheet for the range of valid values.
CARR,OFST	<offset>	:= carrier offset. The unit is volts "V". Refer to the datasheet for the range of valid values.
CARR,SYM	<symmetry>	:= {0 to 100}. Carrier symmetry when the carrier is RAMP. The unit is "%".
CARR,DUTY	<duty>	:= {0 to 100}. Carrier duty cycle when the carrier is SQUARE or PULSE. The unit is "%".
CARR,RISE	<rise>	:= rise time when the carrier is PULSE. The unit is seconds "s". Refer to the datasheet for the range of valid values.
CARR,FALL	<fall>	:= fall time when the carrier is PULSE. The unit is seconds "s". Refer to the datasheet for the range of

		valid values.
CARR,DLY	<delay>	:= pulse delay when the carrier is PULSE. The unit is seconds "s". Refer to the datasheet for the range of valid values.

Notes:

1. Modulation is not available if the carrier wave is Noise.
2. The range of some parameters depends on the model. Refer to the datasheet for details.

QUERY SYNTAX <channel>:MoDulateWaVe?
 <channel>:={C1, C2}.

RESPONSE FORMAT <channel>:MDWV <parameter>
 <parameter>:= {all parameters of the current modulation}.

EXAMPLE

Set CH1 modulation state to on:

C1:MDWV STATE,ON

Set CH1 modulation type to AM:

C1:MDWV AM

Set modulation to AM, and the modulating wave type to sine wave:

C1:MDWV AM,MDSP,SINE

Read CH1 modulation parameters when STATE is ON:

C1:MDWV?

Return:

*C1:MDWV AM,STATE,ON,MDSP,SINE,SRC,INT,FRQ,100HZ,
 DEPTH,100,CARR,WVTP,RAMP,FRQ,1000HZ,AMP,4V,
 AMPVRMS,1.15473Vrms,OFST,0V,PHSE,0,SYM,50*

Read CH1 modulate wave parameters when STATE is OFF:

C1:MDWV?

Return:

C1:MDWV STATE,OFF

Set CH1 FM frequency to 1000 Hz:

C1:MDWV FM,FRQ,1000

Set CH1 carrier to SINE:

C1:MDWV CARR,WVTP,SINE

Set CH1 carrier frequency to 1000 Hz:

C1:MDWV CARR,FRQ,1000

Note: The table below shows the availability of some command parameters in each SDG series.

Parameter /command	SDG800	SDG1000	SDG2000X	SDG5000	SDG1000X	SDG6000X/X-E	SDG7000A
<channel>	no	yes	yes	yes	yes	yes	yes
<type>, SRC	no	yes	yes	yes	yes	yes	yes
CARR, DLY	no	yes	yes	yes	yes	yes	yes
CARR, RISE	yes	no	yes	yes	yes	yes	yes
CARR, FALL	yes	no	yes	yes	yes	yes	yes

<type>:= {AM, FM, PM, FSK, ASK, PSK, DSBAM, PWM}.

3.6 Sweep Wave Command

DESCRIPTION This command sets or gets the sweep parameters.

COMMAND SYNTAX

```
<channel>:SweepWaVe <parameter>,<value>
<channel>:={C1, C2}
<parameter>:= {a parameter from the table below}
<value>:={value of the corresponding parameter}
```

Parameters	Value	Description
STATE	<state>	:= {ON, OFF}. Enable or disable sweep. STATE must be set to ON before you set or read other parameters of the sweep.
TIME	<time>	:= sweep time. The unit is seconds "s". Refer to the datasheet for the range of valid values.
STARTTIME	<time>	:= {0 to 300}. The unit is seconds "s". Start hold time
ENDTIME	<time>	:= {0 to 300}. The unit is seconds "s". End hold time
BACKTIME	<time>	:= {0 to 300}. The unit is seconds "s". Back time
START	<start_freq>	:= start frequency. The same with basic wave frequency. The unit is Hertz "Hz".
STOP	<stop_freq>	:= stop frequency. The same with basic wave frequency. The unit is Hertz "Hz".
CENTER	<center_freq>	:= center frequency. The unit is Hertz "Hz". Refer to the datasheet for the range of valid values.
SPAN	<span_freq>	:= frequency span. The unit is Hertz "Hz". Refer to the datasheet for the range of valid values.
SWMD	<sweep_mode>	:= {LINE, LOG, STEP}, in which LINE refers to Linear, LOG refers to Logarithmic and STEP refers to step.
DIR	<direction>	:= {UP, DOWN, UP_DOWN}. Sweep direction.
SYM	<symmetry>	:= {0% to 100%}. The symmetry when sweep direction is up.
TRSR	<trig_src>	:= {EXT, INT, MAN}. Trigger source. EXT refers to External, INT refers to Internal and MAN refers to

		Manual.
MTRIG		:= send a manual trigger. Only valid when TRSR is MAN.
TRMD	<trig_mode>	:= {ON, OFF}. State of trigger output. If TRSR is EXT, the parameter is invalid.
EDGE	<edge>	:= {RISE, FALL}. Available trigger edge. Only valid when TRSR is EXT or MAN.
CARR, WVTP	<wave type>	:= {SINE, SQUARE, RAMP, ARB}. Carrier waveform type. Modulation is not available if the carrier is PULSE, NOISE, or DC.
CARR, FRQ	<frequency>	:= carrier frequency. The unit is Hertz "Hz". Refer to the datasheet for the range of valid values.
CARR, PHSE	<phase>	:= {0 to 360}. Carrier phase. The unit is "degree".
CARR, AMP	<amplitude>	:= carrier amplitude. The unit is volts, peak-to-peak "Vpp". Refer to the datasheet for the range of valid values.
CARR, OFST	<offset>	:= carrier offset. The unit is volts "V". Refer to the datasheet for the range of valid values.
CARR, SYM	<symmetry>	:= {0 to 100}. Carrier symmetry when the carrier is RAMP. The unit is percent "%".
CARR, DUTY	<duty>	:= {0 to 100}. Carrier duty cycle when the carrier is SQUARE. The unit is "%".
MARK_STATE	<state>	:= {ON, OFF}.
MARK_FREQ	<frequency>	:= mark frequency. The unit is Hertz "Hz". The range is from the start frequency to the stop frequency.

QUERY SYNTAX <channel>:SWEEPWaVe?

<channel>:= {C1, C2}.

RESPONSE FORMAT <channel>:SWWV <parameter>

<parameter>:= {All parameters of the current sweep wave}

EXAMPLE Set CH1 sweep state to ON:

C1:SWWV STATE,ON

Set CH1 sweep time to 1 s:

```
C1:SWWV TIME,1
```

Set CH1 stop frequency to 1000 Hz:

```
C1:SWWV STOP,1000
```

Set the trigger source of CH1 to Manual:

```
C1:SWWV TRSR,MAN
```

Send a manual trigger to CH1:

```
C1:SWWV MTRIG
```

Read CH2 sweep parameters when STATE is ON:

```
C2:SWWV?
```

Return:

```
C2:SWWVSTATE,ON,TIME,1S,STOP,1500HZ,START,500HZ,  
CENTER,1000HZ,
```

```
SPAN,1000HZ,TRSR,INT,TRMD,OFF,SWMD,LINE,DIR,UP,SYM,  
0,MARK_STATE,
```

```
OFF,MARK_FREQ,1000HZ,CARR,WVTP,SINE,FRQ,1000HZ,  
AMP,4V,AMPVRMS,
```

```
1.41421Vrms,OFST,0V,PHSE,0
```

Read CH2 sweep parameters when STATE is OFF:

```
C2:SWWV?
```

Return:

```
C2:SWWV STATE,OFF
```

Set CH1 the FreqMarker of sweep to 1kHz

```
C1:SWWV MARK_STATE,ON,MARK_FREQ,1000
```

Note: The table below shows the availability of some command parameters in each SDG series.

Parameter /command	SDG800	SDG1000	SDG2000X	SDG5000	SDG1000X	SDG6000X/X-E	SDG7000A
<channel>	no	yes	yes	yes	yes	yes	yes
TRMD	no	yes	yes	yes	yes	yes	yes
EDGE	no	yes	yes	yes	yes	yes	yes

3.7 Burst Wave Command

DESCRIPTION This command sets or gets the burst wave parameters.

COMMAND SYNTAX <channel>:BursTWaVe <parameter>,<value>
 <channel>:= {C1, C2}.
 <parameter>:= {a parameter from the table below}.
 <value>:= {value of the corresponding parameter}.

Parameters	Value	Description
STATE	<state>	:= {ON, OFF}. Enable or disable burst. STATE must be set to ON before you set or read other parameters of the burst.
PRD	<period>	:= burst period. Refer to the datasheet for the range of valid values. The unit is seconds "s" Not valid when: <ul style="list-style-type: none"> Carrier is NOISE GATE_NCYC is GATE (except the "X" series) TRSR is EXT
STPS	<start_phase>	:= {0 to 360}. Start phase of the carrier. The unit is "degree". Not valid when the carrier is NOISE or PULSE.
GATE_NCYC	<burst_mode>	:= {GATE, NCYC}. Burst mode. Not valid when the carrier is NOISE.
TRSR	<trig_src>	:= {EXT, INT, MAN}. Trigger source. EXT refers to External, INT refers to Internal and MAN refers to Manual.
MTRIG		:= send a manual trigger. Only when TRSR is MAN, the parameter is valid.
DLAY	<delay>	:= trigger delay. The unit is seconds "s". Refer to the datasheet for the range of valid values. Available when GATE_NCYC is NCYC. Not valid when the carrier is NOISE.
PLRT	<polarity>	:= {NEG, POS}. Gate polarity. Negative or Positive.
TRMD	<trig_mode>	:= {RISE, FALL, OFF}. Trigger out mode. Available when GATE_NCYC is NCYC and TRSR is INT or MAN. Not valid when the carrier is NOISE.
EDGE	<edge>	:= {RISE, FALL}. Available trigger edge. Only valid when TRSR is EXT or MAN.

EDGE	<edge>	:= { RISE, FALL}. Available trigger edge. Available when GATE_NCYC is NCYC and TRSR is EXT. Not valid when the carrier is NOISE.
TIME	<circle_time>	:= {INF, 1, 2,..., M}, where M is the maximum supported Ncycle number which depends on the model; INF sets the burst to Infinite mode. Available when GATE_NCYC is NCYC. Not valid when the carrier is NOISE.
COUNT	<counter>	:=Burst count, Only valid when TRSR is EXT or MAN.
CARR, WVTP	<wave type>	:= {SINE, SQUARE, RAMP, ARB, PULSE, NOISE}. Carrier waveform type.
CARR, FRQ	<frequency>	:= carrier frequency. The unit is Hertz "Hz". Refer to the datasheet for the range of valid values.
CARR, PHSE	<phase>	:= {0 to 360}. Carrier phase. The unit is "degree".
CARR, AMP	<amplitude>	:= carrier amplitude. The unit is volts, peak-to-peak "Vpp". Refer to the datasheet for the range of valid values.
CARR, OFST	<offset>	:= carrier offset. The unit is volts "V". Refer to the datasheet for the range of valid values.
CARR, SYM	<symmetry>	:= {0 to 100}. Carrier symmetry when the carrier is RAMP. The unit is "%".
CARR, DUTY	<duty>	:= {0 to 100}. Carrier duty cycle when the carrier is SQUARE or PULSE. The unit is "%".
CARR, RISE	<rise>	:= rise time when the carrier is PULSE. The unit is seconds "s". Refer to the datasheet for the range of valid values.
CARR, FALL	<fall>	:= fall time when the carrier is PULSE. The unit is seconds "s". Refer to the datasheet for the range of valid values.
CARR, DLY	<delay>	:= pulse delay when the carrier is PULSE. The unit is seconds "s". Refer to the datasheet for the range of valid values.
CARR, STDEV	<stdev>	:= standard deviation of NOISE. The unit is volts "V". Refer to the datasheet for the range of valid values.
CARR, MEAN	<mean>	:= mean of NOISE. The unit is volts "V". Refer to the datasheet for the range of valid values.

QUERY SYNTAX

<channel>:BTWV(BurstTWaVe)?

<channel>:={C1, C2}

RESPONSE FORMAT

<channel>:BTWV <parameter>

<parameter>:={All parameters of the current burst wave.}

EXAMPLE

Set CH1 burst state to ON

C1:BTWV STATE,ON

Set CH1 burst period to 1 s.

C1:BTWV PRD,1

Set CH1 burst delay to 1 s

C1:BTWV DLAY,1

Set CH1 burst to infinite

C1:BTWV TIME,INF

Read CH2 burst parameters when the STATE is ON.

C2:BTWV?

Return:

*C2:BTWV STATE,ON,PRD,0.01S,STPS,0,TRSR,INT,
TRMD,OFF,TIME,1,DLAY,2.4e-07S,GATE_NCYC,NCYC,
CARR,WVTP,SINE,FRQ,1000HZ,AMP,4V,OFST,0V,PHSE,0*

Read CH2 burst parameters when the STATE is OFF.

C2:BTWV?

Return:

C2:BTWV STATE,OFF

Note: The table below shows the availability of some command parameters in each SDG series.

Parameter /command	SDG800	SDG1000	SDG2000X	SDG5000	SDG1000X	SDG6000X/X-E	SDG7000A
<channel>	no	yes	yes	yes	yes	yes	yes
TRMD	no	yes	yes	yes	yes	yes	yes
EDGE	no	yes	yes	yes	yes	yes	yes
CARR, DLY	yes	yes	yes	yes	yes	yes	yes
CARR, RISE	yes	no	yes	yes	yes	yes	yes
CARR, FALL	yes	no	yes	yes	yes	yes	yes

3.8 Parameter Copy Command

DESCRIPTION This command copies parameters from one channel to another.

COMMAND SYNTAX ParaCoPy <destination_channel>,<src_channel>

< destination_channel>:= {C1, C2}.

<src_channel>:= {C1, C2}.

Note: the parameters C1 and C2 must be set to the device together.

EXAMPLE Copy parameters from CH1 to CH2.

PACP C2,C1

Note: The table below shows the availability of the command in each SDG series.

Parameter /command	SDG800	SDG1000	SDG2000X	SDG5000	SDG1000X	SDG6000X/X-E	SDG7000A
PACP	no	yes	yes	yes	yes	yes	yes

3.9 Arbitrary Wave Command

DESCRIPTION	<p>This command sets and gets the arbitrary waveform type.</p> <p>Note: The index number in the command syntax and the response format of the query omits the character and directly uses the value to represent the index number.</p>
COMMAND SYNTAX	<p>Format1: <channel>:ArbWaVe INDEX,<index> Format2: <channel>:ArbWaVe NAME,<name> Format3: <channel>:ArbWaVe NAME,<path></p> <p><channel>:= {C1, C2}. <index>: the index of the arbitrary waveform from the table below. <name>: the name of the arbitrary waveform from the table below. <path>: the path of waveform</p>
QUERY SYNTAX	<p><channel>:ARbWaVe? <channel>:= {C1, C2}.</p>
RESPONSE FORMAT	<p><channel>:ARWV INDEX,<index>,NAME,<name></p>
EXAMPLE	<p>Set CH1 current waveform by index 2: <i>C1:ARWV INDEX,2</i></p> <p>Read CH1 current waveform: <i>C1:ARWV?</i> Return: <i>C1:ARWV INDEX,2,NAME,StairUp</i></p> <p>Set CH1 current waveform to wave_1 by name. <i>C1:ARWV NAME,"wave_1"</i></p> <p>Set the waveform of ch1 through the waveform path: <i>C1:ARWV NAME,"Local/wave1.bin"</i> <i>C1:ARWV NAME,"Local/wave2.mat"</i> <i>C1:ARWV NAME,"Local/wave3.csv"</i></p>

C1:ARWV NAME,"net_storage/wave4.bin"

C1:ARWV NAME,"U-disk0/wave1.bin"

NOTE The specific path refers to the path in the file manager

RELATED COMMANDS [STL](#)

Index	Name	Index	Name	Index	Name	Index	Name
0	Sine	51	AttALT	102	LFPulse	153	Duty18
1	Noise	52	RoundHalf	103	Tens1	154	Duty20
2	StairUp	53	RoundsPM	104	Tens2	155	Duty22
3	StairDn	54	BlaseiWave	105	Tens3	156	Duty24
4	Stairud	55	DampedOsc	106	Airy	157	Duty26
5	Ppulse	56	SwingOsc	107	Besselj	158	Duty28
6	Npulse	57	Discharge	108	Bessely	159	Duty30
7	Trapezia	58	Pahcur	109	Dirichlet	160	Duty32
8	Upramp	59	Combin	110	Erf	161	Duty34
9	Dnramp	60	SCR	111	Erfc	162	Duty36
10	ExpFal	61	Butterworth	112	ErfcInv	163	Duty38
11	ExpRise	62	Chebyshev1	113	ErfInv	164	Duty40
12	Logfall	63	Chebyshev2	114	Laguerre	165	Duty42
13	Logrise	64	TV	115	Legend	166	Duty44
14	Sqrt	65	Voice	116	Versiera	167	Duty46
15	Root3	66	Surge	117	Weibull	168	Duty48
16	X ²	67	Radar	118	LogNormal	169	Duty50
17	X ³	68	Ripple	119	Laplace	170	Duty52
18	Sinc	69	Gamma	120	Maxwell	171	Duty54
19	Gaussian	70	StepResp	121	Rayleigh	172	Duty56
20	Dlorentz	71	BandLimited	122	Cauchy	173	Duty58
21	Haversine	72	CPulse	123	CosH	174	Duty60
22	Lorentz	73	CWPulse	124	CosInt	175	Duty62

23	Gauspuls	74	GateVibr	125	CotH	176	Duty64
24	Gmonopuls	75	LFMPulse	126	CscH	177	Duty66
25	Tripuls	76	MCNoise	127	SecH	178	Duty68
26	Cardiac	77	AM	128	SinH	179	Duty70
27	Quake	78	FM	129	SinInt	180	Duty72
28	Chirp	79	PFM	130	TanH	181	Duty74
29	Twotone	80	PM	131	ACosH	182	Duty76
30	SNR	81	PWM	132	ASecH	183	Duty78
31	Hamming	82	EOG	133	ASinH	184	Duty80
32	Hanning	83	EEG	134	ATanH	185	Duty82
33	Kaiser	84	EMG	135	ACsch	186	Duty84
34	Blackman	85	Pulseilogram	136	ACoth	187	Duty86
35	Gausswin	86	ResSpeed	137	Bartlett	188	Duty88
36	Triang	87	ECG1	138	BohmanWin	189	Duty90
37	BlackmanH	88	ECG2	139	ChebWin	190	Duty92
38	Bartlett	89	ECG3	140	FlattopWin	191	Duty94
39	Tan	90	ECG4	141	ParzenWin	192	Duty96
40	Cot	91	ECG5	142	TaylorWin	193	Duty98
41	Sec	92	ECG6	143	TukeyWin	194	Duty99
42	Csc	93	ECG7	144	Duty01	195	demo1_375
43	Asin	94	ECG8	145	Duty02	196	demo1_16k
44	Acos	95	ECG9	146	Duty04	197	demo2_3k
45	Atan	96	ECG10	147	Duty06	198	demo2_16k
46	Acot	97	ECG11	148	Duty08		
47	Square	98	ECG12	149	Duty10		
48	SineTra	99	ECG13	150	Duty12		
49	SineVer	100	ECG14	151	Duty14		
50	AmpALT	101	ECG15	152	Duty16		

Note: The below table shows the index of built-in waveforms of different models

	SDG800	SDG1000	SDG2000X	SDG5000	SDG1000X	SDG6000X/X-E	SDG7000A
INDEX	0~46	2~198	2~198	2~198	2~198	2~198	0~198

Note: The table below shows the availability of some command parameters in each SDG series.

Parameter /command	SDG800	SDG1000	SDG2000X	SDG5000	SDG1000X	SDG6000X/X-E	SDG7000A
<channel>	no	yes	yes	yes	yes	yes	yes
INDEX	yes	yes	Yes (only built-in wave)	yes	Yes (only built-in wave)	Yes (only built-in wave)	Yes (only built-in wave)
NAME	yes	yes	Yes (only user-defined wave)	yes	Yes (only user-defined wave)	Yes (only user-defined wave) Format 2	Yes (built-in or user-defined wave) Format2 Format3

3.10 Sync Command

DESCRIPTION

This command sets the synchronization signal.

COMMAND SYNTAX

<channel>:SYNC <state>

<channel>:= {C1, C2}.

<state>:= {ON, OFF}.

SYNC TYPE, <TYPE>

<TYPE>:= {CH1, CH2, MOD_CH1, MOD_CH2}.

QUERY SYNTAX

<channel>:SYNC?

<channel>:= {C1, C2}.

RESPONSE FORMAT <channel>:SYNC <state>

EXAMPLE Turn on sync output and set the source as modulating signal of CH1:

C1:SYNC ON,TYPE,MOD_CH1

Read the state of CH1 sync.

C1:SYNC?

Return:

C1:SYNC ON,TYPE,MOD_CH1

Note: The table below shows the availability of the command in each SDG series.

Parameter /command	SDG800	SDG1000	SDG2000X	SDG5000	SDG1000X	SDG6000X/X-E	SDG7000A
SYNC	no	yes	yes	yes	yes	yes	yes

3.11 Equal Phase Command

DESCRIPTION This command is used to set the phase synchronization of two channels

COMMAND SYNTAX EQPHASE

RESPONSE FORMAT EQPHASE <state>

EXAMPLE EQPHASE

Note: The table below shows the availability of the command in each SDG series.

Parameter /command	SDG800	SDG1000	SDG2000X	SDG5000	SDG1000X	SDG6000X/X-E	SDG7000A
EQPHASE	no	yes	yes	yes	yes	yes	yes

3.12 Number Format Command

DESCRIPTION	This command sets or gets the number format.
COMMAND SYNTAX	NumBer_ForMat PNT,<pnt>, NumBer_ForMa SEPT,<sept> <pnt>:= {Dot, Comma}. The point format. <sept>:= {Space, Off, On}. The separator format.
QUERY SYNTAX	NBFM?
RESPONSE FORMAT	NBFM PNT,<pnt>, SEPT,<sept>
EXAMPLE	Set point format to DOT: <i>NBFM PNT, DOT</i> Set separator format to ON: <i>NBFM SEPT, ON</i> Read the number format: <i>NBFM?</i> Return: <i>NBFM PNT, DOT, SEPT, ON</i>

Note: The table below shows the availability of the command in each SDG series.

Parameter /command	SDG800	SDG1000	SDG2000X	SDG5000	SDG1000X	SDG6000X/X-E	SDG7000A
NBFM	yes	yes	yes	yes	yes	yes	no

3.13 Language Command

DESCRIPTION	This command sets or gets the system language.
COMMAND SYNTAX	<p>LAnGuaGe <language></p> <p><language>:= {EN,CH,RU}, where EN is English, CH is Chinese Simplified, and RU is Russian.</p>
QUERY SYNTAX	LAnGuaGe?
RESPONSE FORMAT	LAGG <language>
EXAMPLE	<p>Set language to English:</p> <p><i>LAGG EN</i></p> <p>Read language</p> <p><i>LAGG?</i></p> <p>Return:</p> <p><i>LAGG EN</i></p>

Note: The table below shows the availability of some command parameters in each SDG series.

Parameter /command	SDG800	SDG1000	SDG2000X	SDG5000	SDG1000X	SDG6000X/X-E	SDG7000A
RU	no	yes	no	no	no	no	no

3.14 Configuration Command

DESCRIPTION	This command sets or gets the power-on system setting.
COMMAND SYNTAX	<p>Format1: Sys_CFG <mode> <mode>:= {DEFAULT, LAST,USER}</p> <p>Format2: Sys_CFG<config><filepath> <config>:={USER, PRESET} <filepath>:= { The path of the configuration file stored by the user (local, network storage, USB flash disk), including the file name and suffix }</p>
QUERY SYNTAX	Sys_CFG?
RESPONSE FORMAT	<p>SCFG <mode> Sys_CFG<config><filepath></p>
EXAMPLE	<p>Set the power-on system setting to LAST: <i>SCFG LAST</i></p> <p>Set boot recovery file: <i>SCFG USER,"net_storage/config/state.xml"</i> <i>or: SCFG USER,"U-disk0/config/state.xml"</i> <i>or: SCFG USER,SCFG USER,"Local/state.xml"</i></p> <p>Set recovery file: <i>SCFG PRESET,"net_storage/config/state.xml"</i> <i>Or: SCFG PRESET,"U-disk0/config/state.xml"</i> <i>Or: SCFG PRESET,"Local/state.xml"</i></p>

Note 1: the path must be included in English in double quotation marks, and the suffix ".xml" must be added. Please refer to the file manager for specific available paths.

Note 2: Format 2 is only supported by SDG7000A

3.15 Date And Time Command

DESCRIPTION This command sets the date and time of the device

COMMAND SYNTAX SYST:DATE < Date >
 < Date >:= {Date to set, Format: yyyy/mm/dd }.
 SYST:TIME
 < Time >:= { Time to set, Format: hh/mm/ss }.

QUERY SYNTAX SYST:DATE?
 SYST:TIME?

EXAMPLE 1 Set the date to 2021/01/10
SYST:DATE 20210110

EXAMPLE 2 Set the time to 10:06:32
SYST:TIME 100632

Note: the following table shows the availability of some commands in different SDG series

Parameter /command	SDG800	SDG1000	SDG2000X	SDG5000	SDG1000X	SDG6000X/X-E	SDG7000A
MODE	no	no	no	no	no	no	yes

3.16 Power On Command

DESCRIPTION This command is used to set direct power on or key on.

COMMAND SYNTAX POWER:ON:MODE<value>
< value >:= {1, 2}.

Mode 1:Press the power on button to power on

Mode 2:Turn on the power and start it directly

QUERY SYNTAX POWER:ON:MODE?

RESPONSE FORMAT POWER:ON:MODE< value >

EXAMPLE Turn on the power and start it directly:
POWER:ON:MODE 2

Note: the following table shows the availability of some commands in different SDG series

Parameter /command	SDG800	SDG1000	SDG2000X	SDG5000	SDG1000X	SDG6000X/X-E	SDG7000A
MODE	no	no	no	no	no	no	yes

3.17 Key Command

DESCRIPTION	This command is used to turn on or off the front panel keys.
COMMAND SYNTAX	KEY<state> < state >:= {ON, OFF}.
QUERY SYNTAX	KEY?
RESPONSE FORMAT	KEY< state >
EXAMPLE	Turn on the front panel key: <i>KEY ON</i>

Note: Only supported on the SDG7000A series.

3.18 Buzzer Command

DESCRIPTION	This command turns on or off the buzzer.
COMMAND SYNTAX	BUZZer <state> <state>:= {ON, OFF}.
QUERY SYNTAX	BUZZer?
RESPONSE FORMAT	BUZZ <state>
EXAMPLE	Turn on the buzzer: <i>BUZZ ON</i>

3.19 Screen SaverCommand

DESCRIPTION	This command sets or gets the screen saver time. The unit is minutes "m".
COMMAND SYNTAX	SCreen_SaVe <parameter> <parameter>:= {OFF, 1, 5, 15, 30, 60, 120, 300}.
QUERY SYNTAX	SCreen_SaVe?
RESPONSE FORMAT	SCSV <parameter>
EXAMPLE	Set screen saver time to 5 minutes: <i>SCSV 5</i> Read the current screen saver time: <i>SCreen_SaVe?</i> Return: <i>SCSV 5MIN</i>

3.20 Clock Source Command

DESCRIPTION This command sets or gets the clock source.

COMMAND SYNTAX `ROSCillator <src>`
`<src>:= {INT, EXT}`

`ROSCillator 10MOUT,<state>`
`<state>:={ ON,OFF }`

QUERY SYNTAX `ROSC?`

RESPONSE FORMAT `ROSC <src>,10MOUT,<state>`

EXAMPLE Set internal time base as the source:

ROSC INT

Enable 10MHz output:

ROSC 10MOUT,ON

Note: The table below shows the availability of the command in each SDG series.

Parameter /command	SDG800	SDG1000	SDG2000X	SDG5000	SDG1000X	SDG6000X/X-E	SDG7000A
ROSC	no	yes	yes	yes	yes	yes	yes

3.21 Frequency Counter Command

DESCRIPTION This command sets or gets the frequency counter parameters.

COMMAND SYNTAX FreqCouNter <parameter>,<value>
 <parameter>:= {a parameter from the table below}.
 <value>:= {value of the corresponding parameter}.

Parameters	Value	Description
STATE	<state>	:= {ON, OFF} State of frequency counter.
FRQ	<frequency>	Measured frequency. The unit is Hertz "Hz". Can't be set.
PW	<pos_width>	Measured positive width. The unit is seconds "s". Can't be set.
NW	<neg_width>	Measured negative width. The unit is seconds "s". Can't be set.
DUTY	<duty>	Measured duty cycle. The unit is "%". Can't be set.
FRQDEV	<freq_dev>	Measured frequency deviation. The unit is "ppm". Can't be set.
REFQ	<ref_freq>	Expected frequency, for calculating the frequency deviation. The unit is Hertz "Hz".
TRG	<triglev>	Trigger level. The range of valid values depends on the model. The unit is volts "V".
MODE	<mode>	:= {AC, DC} Coupling mode.
HFR	<HFR>	:= {ON, OFF} State of High Frequency Rejection.

QUERY SYNTAX FreqCouNter?

RESPONSE FORMAT FCNT <parameter>
 <parameter>:={All parameters of the frequency counter}

EXAMPLE Turn frequency counter on:
FCNT STATE,ON

Set reference frequency to 1000 Hz:
FCNT REFQ,1000

Query frequency counter information:
FCNT?

Return:
FCNT STATE,ON,FRQ,10000000HZ,DUTY,59.8568,REFQ,1e+07HZ,TRG,0V,PW,5.98568e-08S,NW,4.01432e-08S,FRQDEV,0ppm,MODE,AC,HFR,OFF

Note: The table below shows the availability of the command in each SDG series.

Parameter /command	SDG800	SDG1000	SDG2000X	SDG5000	SDG1000X	SDG6000X/X-E	SDG7000A
FCNT	no	yes	yes	yes	yes	yes	no

3.22 Counter Command

COMMAND SYNTAX :SENSe:COUNTer

DESCRIPTION It is used to set and obtain various parameters of the counter.
See 3.22.1 ~ 0 for detailed commands

This command sets the counter configuration

COMMAND SYNTAX SENSe:COUNTer:CONFig: < parameter > <value>
< parameter >:={ Parameters in the following table }
< value >:={ Values of related parameters }

parameter	value	description
STATe	<state>	= { OFF, ON } or { 0, 1 }, turn on or off the counter
MODE	<state>	:= { FREQuency, TOTALizer } Frequency meter mode or counter mode
COUPLing	<mode>	:= { AC, DC } Coupling mode
HFREJect	<HFR>	:= { OFF, ON } or { 0, 1 } High frequency suppression state
TLEVel	<triglev><unit>	Trigger level. The range of valid values depends on the model. The unit is volts "V". < unit > := { V, mV, uV }
SEXIT	<mode>	= { OFF, ON } or { 0, 1 }
PAUSE	<state>	= { OFF, ON }, Pause switch

QUERY SYNTAX :SENSe:COUNTer:CONFig: < parameter > ?

RESPONSE FORMAT <mode>

EXAMPLE Set the counter coupling mode to AC mode:
:SENSe:COUNTer:CONFig:COUPLing AC

DESCRIPTION This command sets the measurement parameters in the frequency meter mode

COMMAND SYNTAX SENSE:COUNTER:FREQUENCY: < parameter > <value>
 < parameter >:={ Parameters in the following table }
 :< value >:={ Values of related parameters }.

parameter	value	description
MEASure	< type >	<type>:={ FREQ, PERIOD, DUTY_CYCLE }
RFREQUENCY	<frequency><unit>	<unit> := {Hz, MHz, GHz}.The default unit is Hz

QUERY SYNTAX :SENSE:COUNTER:FREQUENCY:MEASURE[:type]?
 RESPONSE FORMAT <mode>

EXAMPLE Set the measurement type in frequency meter mode as period:
:SENSE:COUNTER:FREQUENCY:MEASURE PERIOD

DESCRIPTION This command is used to query the measurement results in the frequency meter mode

COMMAND SYNTAX :SENSE:COUNTER:FREQUENCY:
 < Measurement type >:< parameter ><[type]>?>

< Measurement type >:={ default, PERIOD, DUTY } Frequency, cycle and duty cycle

< parameter >:={ default, SNUMBER , MEAN, MAX, MIN, SDEVIATION } Real time value of measurement type, sampling times of measurement type, average value of measurement type,

maximum value of measurement type, minimum value of measurement type and standard deviation of measurement type

< type >:={ FDEViation }. Available only when the measurement type is frequency mode

QUERY SYNTAX

:SENSe:COUNTer:FREQuency:SNUMBer?

RESPONSE FORMAT <mode>

:SENSe:COUNTer:CONFig:COUPLing[:MODE] AC

DESCRIPTION

This command is used to set the measurement parameters in counter mode

COMMAND SYNTAX

:SENSe:COUNTer: TOTalizer: < parameter > < value >

< parameter >:={ Parameters in the following table }

< value >:={ Values of related parameters }.

parameter	value	describe
GATE:STATe	< type >	<state>:={ OFF, ON} or {0, 1}
EDGE	<edge>	< edge >:={ RISE, FALL}
GATE:MODE	<mode>	<mode>:={LEVEL, AFTER_EDGE}
GOLarity:GATE:POLarity	< polarity >	< polarity >:={ NEGative, POSitive}
GOLarity:GATE:EDGE	< edge >	< edge >:={ RISE, FALL}

3.22.1 :SENSe:COUNTer:CLEAr

DESCRIPTION This command is used to clear the measurement results

QUERY SYNTAX :SENSe:COUNTer:CLEAr

RESPONSE FORMAT

EXAMPLE Clear the measurement results:

:SENSe:COUNTer:CLEAr

3.22.2 :SENSe:COUNTer:FREQuency:MEASure[:type]

DESCRIPTION This command sets the measurement type in the frequency meter mode

COMMAND SYNTAX :SENSe:COUNTer:FREQuency:MEASure[:type] <type>
<type>:={ **FREQ**, **PERIOD**, **DUTY_CYCLE** }

QUERY SYNTAX :SENSe:COUNTer:FREQuency:MEASure?

RESPONSE FORMAT <type>

EXAMPLE Set the measurement type in frequency meter mode as period:

:SENSe:COUNTer:FREQuency:MEASure PERIOD

NOTE This command is only valid in frequency meter mode

3.22.3 :SENSe:COUNTer:FREQuency:RFREQuency

DESCRIPTION	This command sets the reference frequency in the frequency meter mode
COMMAND SYNTAX	<code>:SENSe:COUNTer:FREQuency:RFREQuency < frequency ><unit></code> < frequency >:= the reference frequency of frequency meter,Please refer to the data manual for the valid range of this parameter. < unit > := {Hz, MHz, GHz}. The default unit is Hz
QUERY SYNTAX	<code>:SENSe:COUNTer:FREQuency:RFREQuency?</code>
RESPONSE FORMAT	< frequency > (Expressed in HZ)
EXAMPLE	Set the reference frequency in the frequency meter mode to 1MHz: <code>:SENSe:COUNTer:FREQuency:RFREQuency 1MHZ</code>
NOTE	This command is only valid when the measurement type is frequency in counter mode

3.22.4 :SENSe:COUNTer:FREQuency?

DESCRIPTION	This command is used to query the frequency results measured in the frequency meter mode
QUERY SYNTAX	<code>:SENSe:COUNTer:FREQuency?</code>
RESPONSE FORMAT	< frequency > (Expressed in Hz)
EXAMPLE	Query the frequency results measured in the frequency meter mode: <code>:SENSe:COUNTer:FREQuency?</code>

Return value
9999996.75781744

NOTE This command is only valid in frequency meter mode

3.22.5 :SENSe:COUNTer:FREQuency:SNUMBer?

DESCRIPTION This command is used to query the results of sampling times in frequency meter mode

QUERY SYNTAX :SENSe:COUNTer:FREQuency:SNUMBer?

RESPONSE FORMAT < sampling times >

EXAMPLE Query the results of sampling times in frequency meter mode:
:SENSe:COUNTer:FREQuency:SNUMBer?

Return value:
2294

NOTE This command is only valid in frequency meter mode

3.22.6 :SENSe:COUNTer:FREQuency:FDEVIation?

DESCRIPTION This command is used to query the frequency deviation results measured in the frequency meter mode

QUERY SYNTAX :SENSe:COUNTer:FREQuency:FDEVIation?

RESPONSE FORMAT < frequency deviation > (Expressed in ppm)

EXAMPLE Query the frequency deviation results measured in the frequency meter mode:

:SENSe:COUNTer:FREQuency:FDEViation?

Return value:

-0.324020794406533

NOTE This command is only valid in frequency meter mode

3.22.7 :SENSe:COUNTer:FREQuency:MEAN?

DESCRIPTION This command is used to query the frequency average value measured in the frequency meter mode

QUERY SYNTAX :SENSe:COUNTer:FREQuency:MEAN?

RESPONSE FORMAT < frequency > (Expressed in Hz)

EXAMPLE Query the frequency results measured in the frequency meter mode:

:SENSe:COUNTer:FREQuency:MEAN?

Return value:

9999996.79101083

NOTE This command is only valid in frequency meter mode

3.22.8 :SENSe:COUNTer:FREQuency:MEAN:FDEViation?

DESCRIPTION This command is used to query the deviation result of the frequency average value measured in the frequency meter mode

QUERY SYNTAX :SENSe:COUNTer:FREQuency:MEAN:FDEViation?

RESPONSE FORMAT < frequency deviation > (Expressed in ppm)

EXAMPLE Query the deviation results of the average frequency measured in the frequency meter mode:

:SENSe:COUNTer:FREQuency:MEAN:FDEViation?

Return value:

-0.322511510334804

NOTE This command is only valid in frequency meter mode

3.22.9 :SENSe:COUNTer:FREQuency:MAX?

DESCRIPTION This command is used to query the maximum frequency measured in the frequency meter mode

QUERY SYNTAX :SENSe:COUNTer:FREQuency:MAX?

RESPONSE FORMAT < frequency > (Expressed in Hz)

EXAMPLE Query the maximum frequency measured in the frequency meter mode:

:SENSe:COUNTer:FREQuency:MAX?

Return value:

9999996.8775536

NOTE This command is only valid in frequency meter mode

3.22.10 :SENSe:COUNTer:FREQuency:MAX:FDEViation?

DESCRIPTION This command is used to query the maximum deviation result of frequency measured in frequency meter mode

QUERY SYNTAX :SENSe:COUNTer:FREQuency:MAX:FDEViation?

RESPONSE FORMAT < frequency deviation > (Expressed in ppm)

EXAMPLE Query the maximum deviation result of frequency measured in frequency meter mode:

:SENSe:COUNTer:FREQuency:MAX:FDEViation?

Return value:

-0.312244639918208

NOTE This command is only valid in frequency meter mode

3.22.11 :SENSe:COUNTer:FREQuency:MIN?

DESCRIPTION This command is used to query the results of the minimum frequency measured in the frequency meter mode

QUERY SYNTAX :SENSe:COUNTer:FREQuency:MIN?

RESPONSE FORMAT < frequency > (Expressed in Hz)

EXAMPLE Query the result of the minimum frequency measured in the frequency meter mode:

:SENSe:COUNTer:FREQuency:MIN?

Return value:

9999996.67704201

NOTE This command is only valid in frequency meter mode

3.22.12 :SENSe:COUNTer:FREQuency:MIN:FDEViation?

DESCRIPTION	This command is used to query the minimum deviation result of frequency measured in frequency meter mode
QUERY SYNTAX	:SENSe:COUNTer:FREQuency:MIN:FDEViation?
RESPONSE FORMAT	< frequency deviation > (Expressed in ppm)
EXAMPLE	Query the minimum deviation result of frequency measured in frequency meter mode: <i>:SENSe:COUNTer:FREQuency:MIN:FDEViation?</i> Return value: <i>-0.332295799069107</i>
NOTE	This command is only valid in frequency meter mode

3.22.13 :SENSe:COUNTer:FREQuency:SDEViation?

DESCRIPTION	This command is used to query the frequency standard deviation results measured in the frequency meter mode
QUERY SYNTAX	:SENSe:COUNTer:FREQuency:SDEViation?
RESPONSE FORMAT	< frequency > (Expressed in Hz)
EXAMPLE	Query the frequency standard deviation results measured in the frequency meter mode: <i>:SENSe:COUNTer:FREQuency:SDEViation?</i> Return value: <i>0.395284707521047</i>
NOTE	This command is only valid in frequency meter mode

3.22.14 :SENSe:COUNTe:FREQuency:SDEViation:FDEViation?

DESCRIPTION	This command is used to query the deviation results of the frequency standard deviation measured in the frequency meter mode
QUERY SYNTAX	:SENSe:COUNTe:FREQuency:SDEViation:FDEViation?
RESPONSE FORMAT	< frequency deviation > (Expressed in ppm)
EXAMPLE	Query the deviation result of frequency standard deviation measured in frequency meter mode: <i>:SENSe:COUNTe:FREQuency:SDEViation:FDEViation?</i> Return value: <i>-0.332295799069107</i>
NOTE	This command is only valid in frequency meter mode

3.22.15 :SENSe:COUNTer:FREQuency:PERiod?

DESCRIPTION	This command is used to query the period results measured in the frequency meter mode
QUERY SYNTAX	:SENSe:COUNTer:FREQuency:PERiod?
RESPONSE FORMAT	< period > (Expressed in s)
EXAMPLE	Query the period results measured in the frequency meter mode: <i>:SENSe:COUNTer:FREQuency:PERiod?</i> Return value: <i>1.00000032802047e-07</i>
NOTE	This command is only valid in frequency meter mode

3.22.16 :SENSe:COUNTer:FREQuency:PERiod:MEAN?

DESCRIPTION	This command is used to query the periodic average value measured in the frequency meter mode
QUERY SYNTAX	:SENSe:COUNTer:FREQuency:PERiod:MEAN?
RESPONSE FORMAT	< period > (Expressed in s)
EXAMPLE	Query the period average value measured in the frequency meter mode: <i>:SENSe:COUNTer:FREQuency:PERiod:MEAN?</i> Return value: <i>1.00000032802047e-07</i>
NOTE	This command is only valid in frequency meter mode

3.22.17 :SENSe:COUNTer:FREQuency:PERiod:MAX?

DESCRIPTION	This command is used to query the average value of the period measured in the frequency meter mode
QUERY SYNTAX	:SENSe:COUNTer:FREQuency:PERiod:MAX?
RESPONSE FORMAT	< period > (Expressed in s)
EXAMPLE	Query the maximum value of the period measured in the frequency meter mode: <i>:SENSe:COUNTer:FREQuency:PERiod:MAX?</i> Return value: <i>1.00000033229591e-07</i>
NOTE	This command is only valid in frequency meter mode

3.22.18 :SENSe:COUNTer:FREQuency:PERiod:MIN?

DESCRIPTION	This command is used to query the minimum value of the period measured in the frequency meter mode
QUERY SYNTAX	:SENSe:COUNTer:FREQuency:PERiod:MIN?
RESPONSE FORMAT	< period > (Expressed in s)
EXAMPLE	Query the minimum value of the period measured in the frequency meter mode: <i>:SENSe:COUNTer:FREQuency:PERiod:MIN?</i> Return value: <i>1.00000031224474e-07</i>
NOTE	This command is only valid in frequency meter mode

3.22.19 :SENSe:COUNTer:FREQuency:PERiod:SDEVIation?

DESCRIPTION	This command is used to query the standard deviation results of the period measured in the frequency meter mode
QUERY SYNTAX	:SENSe:COUNTer:FREQuency:PERiod:SDEVIation?
RESPONSE FORMAT	< period > (Expressed in s)
EXAMPLE	Query the standard deviation result of the period measured in the frequency meter mode: <i>:SENSe:COUNTer:FREQuency:PERiod:SDEVIation?</i> Return value: <i>6.52675178645049e-15</i>
NOTE	This command is only valid in frequency meter mode

3.22.20 :SENSe:COUNTer:FREQuency:DUTY?

DESCRIPTION	This command is used to query the duty cycle results measured in the frequency meter mode
QUERY SYNTAX	:SENSe:COUNTer:FREQuency:DUTY?
RESPONSE FORMAT	< duty cycle > (Expressed in %)
EXAMPLE	Query the duty cycle results measured in frequency meter mode: :SENSe:COUNTer:FREQuency:DUTY? Return value: 49.8178520697226
NOTE	This command is only valid in frequency meter mode

3.22.21 :SENSe:COUNTer:FREQuency:DUTY:MEAN?

DESCRIPTION	This command is used to query the average value of the duty cycle measured in the frequency meter mode
QUERY SYNTAX	:SENSe:COUNTer:FREQuency:DUTY:MEAN?
RESPONSE FORMAT	< duty cycle > (Expressed in %)
EXAMPLE	Query the average value of duty cycle measured in frequency meter mode: :SENSe:COUNTer:FREQuency:DUTY:MEAN? Return value: 49.8204827053384
NOTE	This command is only valid in frequency meter mode

3.22.22 :SENSe:COUNTer:FREQuency:DUTY:MAX?

DESCRIPTION	This command is used to query the result of the maximum duty cycle measured in the frequency meter mode
QUERY SYNTAX	:SENSe:COUNTer:FREQuency:DUTY:MAX?
RESPONSE FORMAT	< duty cycle > (Expressed in %)
EXAMPLE	Query the maximum value of duty cycle measured in frequency meter mode: <i>:SENSe:COUNTer:FREQuency:DUTY:MAX?</i> Return value: <i>1.00000033229591e-07</i>
NOTE	This command is only valid in frequency meter mode

3.22.23 :SENSe:COUNTer:FREQuency:DUTY:MIN?

DESCRIPTION	This command is used to query the minimum value of duty cycle measured in frequency meter mode
QUERY SYNTAX	:SENSe:COUNTer:FREQuency:DUTY:MIN?
RESPONSE FORMAT	< duty cycle > (Expressed in %)
EXAMPLE	Query the minimum value of duty cycle measured in frequency meter mode: <i>:SENSe:COUNTer:FREQuency:DUTY:MIN?</i> Return value: <i>49.8071405616451</i>
NOTE	This command is only valid in frequency meter mode

3.22.24 :SENSe:COUNTer:FREQuency:DUTY:SDEVIation?

DESCRIPTION	This command is used to query the standard deviation results of the duty cycle measured in the frequency meter mode
QUERY SYNTAX	:SENSe:COUNTer:FREQuency:DUTY:SDEVIation?
RESPONSE FORMAT	< duty cycle > (Expressed in %)
EXAMPLE	<p>Query the results of periodic standard deviation measured in frequency meter mode:</p> <p><i>:SENSe:COUNTer:FREQuency:DUTY:SDEVIation?</i></p> <p>Return value:</p> <p><i>0.00505753455971934</i></p>
NOTE	This command is only valid in frequency meter mode

3.22.25 :SENSe:COUNTer:TOTalizer:GATE:STATe

DESCRIPTION	This command is used to set the gating state of the totalizer in the totalizer mode
COMMAND SYNTAX	<p>:SENSe:COUNTer:TOTalizer:GATE:STATe <state></p> <p><state>:={ OFF, ON}or{0, 1}</p>
QUERY SYNTAX	:SENSe:COUNTer:TOTalizer:GATE:STATe?
RESPONSE FORMAT	<state>
EXAMPLE	<p>Set the counter gating status in totalizer mode to on:</p> <p><i>:SENSe:COUNTer:TOTalizer:GATE:STATe ON</i></p>
NOTE	This command is only valid when the counter mode is totalizer

3.22.26 :SENSe:COUNTer:TOTalizer:EDGE

DESCRIPTION	This command is used to set the type of totalizer trigger edge in totalizer mode
COMMAND SYNTAX	:SENSe:COUNTer:TOTalizer:EDGE < edge > < edge >:={ RISE, FALL}
QUERY SYNTAX	:SENSe:COUNTer:TOTalizer:EDGE?
RESPONSE FORMAT	< edge >
EXAMPLE	Set the trigger edge type of totalizer in totalizer mode as rising edge: <i>:SENSe:COUNTer:TOTalizer:EDGE RISE</i>
NOTE	This command is only valid when the counter mode is totalizer

3.22.27 :SENSe:COUNTer:TOTalizer:GATE:MODE

DESCRIPTION	This command is used to set the totalizer gating mode in totalizer mode
COMMAND SYNTAX	:SENSe:COUNTer:TOTalizer:GATE:MODE < mode > < mode >:={ LEVEL, AFTER_EDGE}
QUERY SYNTAX	:SENSe:COUNTer:TOTalizer:GATE:MODE?
RESPONSE FORMAT	<state>
EXAMPLE	Set the totalizer gating mode to level mode <i>:SENSe:COUNTer:TOTalizer:GATE:MODE LEVEL</i>
NOTE	This command is only valid when the counter mode is totalizer

3.22.28 :SENSe:COUNTer:TOTalizer:GOLarity:GATE:POLarity

DESCRIPTION	This command is used to set the totalizer gating polarity in totalizer mode
COMMAND SYNTAX	:SENSe:COUNTer:TOTalizer:GATE:POLarity < polarity > < polarity >:={ NEGative, POSitive}
QUERY SYNTAX	:SENSe:COUNTer:TOTalizer:GATE:POLarity?
RESPONSE FORMAT	< polarity >
EXAMPLE	Set the gating polarity of the counter to positive: <i>:SENSe:COUNTer:TOTalizer:GATE:POLarity POSitive</i>
NOTE	This command is only valid when the counter mode is totalizer

3.22.29 :SENSe:COUNTer:TOTalizer:GOLarity:GATE:EDGE

DESCRIPTION	This command is used to set the totalizer gating edge in totalizer mode
COMMAND SYNTAX	:SENSe:COUNTer:TOTalizer:GATE:EDGE < edge > < edge >:={ RISE, FALL}
QUERY SYNTAX	:SENSe:COUNTer:TOTalizer:GATE:EDGE?
RESPONSE FORMAT	< edge >
EXAMPLE	Set the gating edge of the totalizer as the rising edge: <i>:SENSe:COUNTer:TOTalizer:GATE:EDGE RISE</i>
NOTE	This command is only valid when the counter mode is totalizer

3.22.30 :SENSe:COUNTer:TOTalizer?

DESCRIPTION	This command is used to query the cumulative value results measured in totalizer mode
QUERY SYNTAX	:SENSe:COUNTer:TOTalizer?
RESPONSE FORMAT	< totalize >(Expressed in hits)
EXAMPLE	Query cumulative value results measured in totalizer mode : <i>SENSe:COUNTer:TOTalizer?</i> Return value: <i>13364879033</i>
NOTE	This command is only valid when the counter mode is totalizer

3.23 Invert Command

DESCRIPTION This command sets or gets the polarity of specified channel.

COMMAND SYNTAX <channel>:INVerT <state>
 <channel>:= {C1, C2}.
 <state>:= {ON, OFF}.

QUERY SYNTAX <channel>:INVerT?
 <channel>:={C1, C2}.

RESPONSE FORMAT <channel>:INVT <state>

EXAMPLE Set CH1 polarity to invert
C1:INVT ON

Read the polarity of CH1.
C1:INVT?

Return:
C1:INVT ON

Note: The table below shows the availability of some command parameters in each SDG series.

Parameter /command	SDG800	SDG1000	SDG2000X	SDG5000	SDG1000X	SDG6000X/X-E	SDG7000A
<channel>	no	yes	yes	yes	yes	yes	yes

3.24 Digital Filter Command

DESCRIPTION This command is used to set the switching and cut-off frequency of the digital filter.

COMMAND SYNTAX <channel>:FILTer< parameter >,<value>
 < parameter >:={ Parameters in the following table}.
 < value >:={Values of related parameters}.

parameters	value	description
STATE	<state>	:= {ON, OFF} Digital filter status
COFF_FRQ	<cutoff_freq>	:= { Device bandwidth },The unit is Hertz 'Hz", used to set the cut-off frequency of the digital filter

QUERY SYNTAX < channel > FILTer?
 < channel >:={C1,C2}.

RESPONSE FORMAT < channel >: FILT < parameter >,< value >

EXAMPLE Set the digital filter of CH1 on:
C1:FILT STATE,ON
 Set the cut-off frequency of the digital filter of CH1 to 200 MHz:
C1:FILT COFF_FRQ,200000000
 Query the digital filter information of CH1:
C1:FILT?
 Return value:
STATE,OFF,COFF_FRQ,350000000HZ

Note: the following table shows the availability of some commands in different SDG series

Parameters /Commands	SDG800	SDG1000	SDG2000X	SDG5000	SDG1000X	SDG6000X/X-E	SDG7000A
STATE	no	no	no	no	no	no	yes
COFF_FRQ	no	no	no	no	no	no	yes

3.25 Coupling Command

DESCRIPTION This command sets or gets the channel coupling parameters. Only when TRACE is set to OFF, the other coupling parameters can be set.

COMMAND SYNTAX COUPling <parameter>,<value>
 <parameter>:= {a parameter from the table below}.
 <value>:={value of the corresponding parameter}.

Parameters	Value	Description
TRACE	<track_enable>	:= {ON, OFF} State of channel tracking.
STATE	<state>	:= {ON, OFF} State of channel coupling.
BSCH	<bsch>	:= {CH1, CH2} Base channel.
FCOUP	<fcoup>	:= {ON, OFF} State of frequency coupling
FDEV	<frq_dev>	:= frequency deviation between the 2 channels. The unit is Hertz "Hz".
FRAT	<frat>	:= frequency ratio between the 2 channels.
PCOUP	<pcoup>	:= {ON, OFF} State of phase coupling
PDEV	<pha_dev>	:= phase deviation between the 2 channels. The unit is degree "°".
PRAT	<prat>	:= phase ratio between the 2 channels.
ACOUP	<acoup>	:= {ON, OFF} State of amplitude coupling
ARAT	<arat>	:= amplitude ratio between the 2 channels.
ADEV	<adev>	:= amplitude deviation between the 2 channels. The unit is volts, peak-to-peak "Vpp".

QUERY SYNTAX

COUPling?

RESPONSE FORMAT

COUP <parameter>

<parameter>:= { All parameters of coupling}.

EXAMPLE

Set coupling state to ON:

COUP STATE,ON

Set frequency coupling state to ON:

COUP FCOUP,ON

Set frequency deviation to 5 Hz:

COUP FDEV,5

Query coupling information.

COUP?

Return:

*COUP TRACE,OFF,FCOUP,ON,PCOUP,ON,ACOUP,ON,FDEV,
5HZ,PRAT,1,ARAT,2*

Note: The table below shows the availability of the command and some parameters in each SDG series.

Parameter /command	SDG800	SDG1000	SDG2000X	SDG5000	SDG1000X	SDG6000X/X-E	SDG7000A
COUP	no	yes	yes	yes	yes	yes	yes
TRACE	no	no	yes	no	yes	yes	yes
STATE	no	yes	no	yes	no	no	no
BSCH	no	yes	no	yes	no	no	no
FCOUP	no	no	yes	no	yes	yes	yes
FRAT	no	no	Yes	no	yes	yes	yes
PCOUP	no	no	Yes	no	yes	yes	yes
PRAT	no	no	Yes	no	yes	yes	yes
ACOUP	no	no	Yes	no	yes	yes	yes
ARAT	no	no	Yes	no	yes	yes	yes
ADEV	no	no	yes	no	yes	yes	yes

3.26 Over-Voltage Protection Command

DESCRIPTION This command sets or gets the state of over-voltage protection.

COMMAND SYNTAX VOLTPRT <state>
<state>:= {ON, OFF}

QUERY SYNTAX VOLTPRT?

RESPONSE FORMAT VOLTPRT <state>

Note: The table below shows the availability of the command in each SDG series.

Parameter /command	SDG800	SDG1000	SDG2000X	SDG5000	SDG1000X	SDG6000X/X-E	SDG7000A
VOLTPRT	no	yes	yes	no	yes	yes	yes

3.27 Over-Current Protection Command

DESCRIPTION This command sets or gets the state of over-current protection.

COMMAND SYNTAX CURRPRT< state >
< state >:= {ON,OFF}

QUERY SYNTAX CURRPRT?

RESPONSE FORMAT CURRPRT < state >

Note: The table below shows the availability of the command in each SDG series.

Parameter /command	SDG800	SDG1000	SDG2000X	SDG5000	SDG1000X	SDG6000X/X-E	SDG7000A
CURRPRT	no	yes	yes	no	yes	yes	yes

3.28 Overload Status Query Command

DESCRIPTION	This command is used to obtain the current overload status (overvoltage, overcurrent, none)
COMMAND SYNTAX	VOLTSTAT?
QUERY SYNTAX	VOLTSTAT?

Note: The table below shows the availability of the command in each SDG series.

Parameter /command	SDG800	SDG1000	SDG2000X	SDG5000	SDG1000X	SDG6000X/X-E	SDG7000A
VOLTSTAT?	no	yes	yes	no	yes	yes	yes

3.29 Output Skew

DESCRIPTION	This command is used to set or query output skew.
COMMAND SYNTAX	<code><channel>:OUTPut:SKEW <value></code> <code>< channel >={C1,C2}</code> <code>< value >={-0.2 to 0.2},unit "ns"</code>
QUERY SYNTAX	<code>< channel >:OUTPut:SKEW?</code> <code>< channel >={C1,C2}</code>
RESPONSE FORMAT	<code>< value ></code> <code>< value >:={ The value of the current channel setting }</code>
EXAMPLE	Set the output skew of C1 to 0.2ns : <code>C1:OUTPut:SKEW 0.2e-9</code> Query the output skew of C1 :

C1:OUTPut:SKEW?

Return value:

2e-10

Note: The table below shows the availability of the command in each SDG series.

Parameter /command	SDG800	SDG1000	SDG2000X	SDG5000	SDG1000X	SDG6000X/X-E	SDG7000A
	no	no	no	no	no	no	yes

3.30 Store List Command

DESCRIPTION

This command is used to read the stored waveforms list with indexes and names. If the storage unit is empty, the command will return “EMPTY”

QUERY SYNTAX

Format1: SStoreList?

Format2: SStoreList? <parameter>

< parameter >=:{ Parameters in the following table }

Format3: SStoreList? <USER>,<path>

< path >=:{ Specify the path of network storage or USB flash disk, as shown in the table below }

RESPONSE FORMAT

<waveform name>

parameter		function
BUILDIN	< parameter >	Query built-in waveform name and index number
USER	< parameter >	Query locally saved waveform name

Path (for example only, you can specify any path under the network storage or USB flash disk directory)		function
"net_storage/wave"	< path >	Query the waveform name saved under the network storage path
"U-disk0/wave"	< path >	Query the waveform name saved in the path of USB flash disk 0
"U-disk1/wave"	< path >	Query the waveform name saved in the path of USB flash disk 1
"U-disk2/wave"	< path >	Query the waveform name saved in the path of USB flash disk 2

EXAMPLE

(1) Read all arbitrary wave names saved in the device (excluding network storage and data in USB flash disk):

STL?

Return:

STL M0, sine, M1, noise, M2, stairup, M3, stairdn, M4, stairud, M5, ppulse, M6, npulse, M7, trapezia, M8, upramp, M9, dn ramp, M10, exp_fall, M11, exp_rise, M12, logfall, M13, logrise, M14, sqrt, M15, root3, M16, x^2, M17, x^3, M18, sinc, M19, gaussian, M20, dlorentz, M21, haversine, M22, lorentz, M23, gauspuls, M24, gmonopuls, M25, tripuls, M26, cardiac, M27, quake, M28, chirp, M29, twotone, M30, snr, M31, EMPTY, M32, EMPTY, M33, EMPTY, M34, hamming, M35, hanning, M36, kaiser, M37, blackman, M38, gaussiwin, M39, triangle, M40, blackmanharris, M41, bartlett, M42, tan, M43, cot, M44, sec, M45, csc, M46, asin, M47, acos, M48, atan, M49, acot, M50, EMPTY, M51, EMPTY, M52, EMPTY, M53, DDROPOUT, M54, FCLK1, M55, FSDA1, M56, EMPTY, M57, EMPTY, M58, EMPTY, M59, EMPTY

(2) Read the built-in waveform name saved in the device:

STL? BUILDIN

Return:

STL M10, ExpFal, M100, ECG14, M101, ECG15, M102, LFPulse, M103, Tens1, M104, Tens2, M105, Tens3, M106, Airy, M107, Besselj, M108, Bessely, M109, Dirichlet, M11, ExpRise, M110, Erf, M111, Erfc, M112, ErfcInv, M113, ErfInv, M114, Laguerre, M115, Legend, M116, Versiera, M117, Weibull, M118, LogNormal, M119,

Laplace, M12, LogFall, M120, Maxwell, M121, Rayleigh, M122, Cauchy, M123, CosH, M124, CosInt, M125, CotH, M126, Csch, M127, SecH, M128, SinH, M129, SinInt, M13, LogRise, M130, TanH, M131, ACosH, M132, ASecH, M133, ASinH, M134, ATanH, M135, ACsch, M136, ACoth, M137, Bartlett, M138, BohmanWin, M139, ChebWin, M14, Sqrt, M140, FlattopWin, M141, ParzenWin, M142, TaylorWin, M143, TukeyWin, M144, SquareDuty01, M145, SquareDuty02, M146, SquareDuty04, M147, SquareDuty06, M148, SquareDuty08, M149, SquareDuty10, M15, Root3, M150, SquareDuty12, M151, SquareDuty14, M152, SquareDuty16, M153, SquareDuty18, M154, SquareDuty20, M155, SquareDuty22, M156, SquareDuty24, M157, SquareDuty26, M158, SquareDuty28, M159, SquareDuty30, M16, X², M160, SquareDuty32, M161, SquareDuty34, M162, SquareDuty36, M163, SquareDuty38, M164, SquareDuty40, M165, SquareDuty42, M166, SquareDuty44, M167, SquareDuty46, M168, SquareDuty48, M169, SquareDuty50, M17, X³, M170, SquareDuty52, M171, SquareDuty54, M172, SquareDuty56, M173, SquareDuty58, M174, SquareDuty60, M175, SquareDuty62, M176, SquareDuty64, M177, SquareDuty66, M178, SquareDuty68, M179, SquareDuty70, M18, Sinc, M180, SquareDuty72, M181, SquareDuty74, M182, SquareDuty76, M183, SquareDuty78, M184, SquareDuty80, M185, SquareDuty82, M186, SquareDuty84, M187, SquareDuty86, M188, SquareDuty88, M189, SquareDuty90, M19, Gaussian, M190, SquareDuty92, M191, SquareDuty94, M192, SquareDuty96, M193, SquareDuty98, M194, SquareDuty99, M195, demo1_375pts, M196, demo1_16kpts, M197, demo2_3kpts, M198, demo2_16kpts, M2, StairUp, M20, Dlorentz, M21, Haversine, M22, Lorentz, M23, Gauspuls, M24, Gmonopuls, M25, Tripuls, M26, Cardiac, M27, Quake, M28, Chirp, M29, Twotone, M3, StairDn, M30, SNR, M31, Hamming, M32, Hanning, M33, kaiser, M34, Blackman, M35, Gausswin, M36, Triangle, M37, Bartlett-Hann, M38, Bartlett, M39, Tan, M4, StairUD, M40, Cot, M41, Sec, M42, Csc, M43, Asin, M44, Acos, M45, Atan, M46, Acot, M47, Square, M48, SineTra, M49, SineVer, M5, Ppulse, M50, AmpALT, M51, AttALT, M52, RoundHalf, M53, RoundsPM, M54, BlaseiWave, M55, DampedOsc, M56, SwingOsc, M57, Discharge, M58, Pahcur, M59, Combin, M6, Npulse, M60, SCR, M61, Butterworth, M62, Chebyshev1, M63, Chebyshev2, M64, TV, M65, Voice, M66, Surge, M67, Radar, M68, Ripple, M69, Gamma, M7, Trapezia, M70, StepResp, M71, BandLimited, M72, CPulse, M73, CWPulse, M74, GateVibr, M75, LFMPulse, M76, MCNoise, M77, AM, M78, FM, M79, PFM, M8, Upramp, M80, PM, M81, PWM, M82, EOG, M83, EEG, M84, EMG, M85, Pulseilogram, M86, ResSpeed, M87, ECG1, M88, ECG2, M89, ECG3, M9, Dnramp, M90, ECG4, M91, ECG5, M92,

ECG6, M93, ECG7, M94, ECG8, M95, ECG9, M96, ECG10, M97, ECG11, M98, ECG12, M99, ECG13

(3) Read user-defined waveform name from the device::

STL? USER

Return:

*STL WVNM,sinc_8M,sinc_3000000,sinc_1664000,
ramp_8M,sinc_2000000,sinc_50000,square_8M,sinc_5000,wave1,
square_1M*

(4) Read waveform data from network storage:

STL? USER,"net_storage/wave"

Return

*net_storage/wave,STLWVNM,AutoWave2,wave1,AutoWave,
ExpFal,test-sq,Besselj,libEasyLib*

Note: The table below shows the availability of some command parameters in each SDG series.

Parameter /command	SDG800	SDG1000	SDG2000X	SDG5000	SDG1000X	SDG6000X/X-E	SDG7000A
STL? return	BUILDIN USER	BUILDIN USER	BUILDIN	BUILDIN USER	BUILDIN	BUILDIN	BUILDIN USRE (Including network storage and USB flash disk storage)
BUILDIN	no	no	yes	no	yes	yes	Yes
USER	no	no	yes	no	yes	yes	Yes
PATH	no	no	no	no	no	no	Yes

3.31 Arb Data Command

DESCRIPTION This command sets and gets the arbitrary waveform data.

COMMAND SYNTAX <channel>:WVDT <index>,<parameter>,<value>
 <channel>:= {C1, C2}.
 <index>:= {Mn}. The waveform index. See note 2 below for the details.
 <parameter>:= {a parameter from the table below}.
 <value>:= {value of the corresponding parameter}.

Parameters	Value	Description
WVNM	<wave_name>	:= waveform name.
TYPE	<type>	:= {0 to 10} 0 - common 1 - math 2 - engineering 3 - window 4 - triangle function 5 - square(5 – user defined SDG6000X/X-E) 6 - Medical Electronics (SDG7000A) 7 – modulation (SDG7000A) 8 – filter (SDG7000A) 9 – presentation (SDG7000A) 10 - user defined (SDG7000A) This parameter is not valid for the “X” series.
LENGTH	<length>	:= the number of waveform bytes, the valid range depends on the model. See note 1 below for the details. This parameter is not necessary for the “X” series
FREQ	<frequency>	:= frequency. The unit is Hertz “Hz”.
AMPL	<amplifier>	:= amplitude. The unit is volts, peak-to-peak “Vpp”.
OFST	<offset>	:= offset. The unit is volts “V”.

PHASE	<phase>	:= phase. The unit is "degree".
WAVEDATA	<wave data>	:= waveform data. The wave data needs to be read from a waveform file

QUERY SYNTAX

Format 1: WVDT? Mn

Format 2: WVDT? USER,<wave_name>

<wave name>:= {The name of user-defined waveform}.

Format3: WVDT? USER,<PATH>,< wave_name>

< Path > specify storage path, such as USB flash disk path. See the following example for network storage path

< waveform name > = {user defined waveform name}

EXAMPLE

Example1

WVDT? USER,"net_storage/wave",wave1

Return

WVDT POS,net_storage/wave, WVNM, wave1, LENGTH, 300B, TYPE, 10,WAVEDATA,

Example2

See section 4.1.5 for the example.

Notes1:

- (1) The path query function must be under the network storage or USB flash disk directory.
When using the command, English quotation marks must be added at both ends of the path.
- (2) The top-level directory of network storage or USB flash disk can be obtained in the file manager.
- (3) Do not specify a path. The default is the local path (format 2).
- (4) Try to fix the directory where waveform files are stored to reduce the waiting time caused by file retrieval.
- (5) The following table shows the paths of different storage methods and is only an example.

path		function
“net_storage/wave”	< path >	Read the waveform file information under the network storage path
“U-disk0/wave”	< path >	Read the waveform file information under the path of USB flash disk 0
“U-disk1/wave”	< path >	Read the waveform file information under the path of USB flash disk 1
“U-disk2/wave”	< path >	Read the waveform file information under the path of USB flash disk 2

Notes2:

(1) The table below shows the availability of some command parameters in each SDG series.

Parameter /command	SDG800	SDG1000	SDG2000X	SDG5000	SDG1000X	SDG6000X-E	SDG6000X	SDG7000A
TYPE	yes	yes	no	yes	no	no	no	yes
<length>	32KB	32KB	4B~16MB	32KB, 1024KB	4B~16MB	4B~16MB	4B~40MB	
USER	no	no	yes	no	yes	yes	yes	yes
Format of WVDT?	Format 1	Format 1	Built-in: Format1 User-defined: Format2	Format 1	Built-in: Format1 User-defined: Format2	Built-in: Format1 User-defined: Format2	Built-in: Format1 User-defined: Format2 Format3	Built-in: Format1 User-defined: Format2 Format3

(2) The table below shows the details of Mn parameters in each SDG series.

Model	Description of Mn
SDG800	0<=n<=59. M0~M49: build-in (32KB). M50~M59: user-defined (32KB).
SDG1000	0<=n<=59. M0~M49: build-in (32KB). M50~M59: user-defined (32KB).
SDG2000X	0<=n<=196. M0~M196: build-in (32KB). Not necessary when sending waveform data.
SDG5000	0<=n<=68. M0~M35: build-in (32KB). M36~M59: user-defined (32KB). M60~M67: user-defined (1024KB).
SDG1000X	0<=n<=196. M0~M196: build-in (32KB). Not necessary when sending waveform data.
SDG6000X/X-E	0<=n<=196. M0~M196: build-in (32KB). Not necessary when sending waveform data.
SDG7000A	0<=n<=198 M0~M198: build-in (32KB).

3.32 Sequence Command

3.32.1 [:SOURce]:<channel>:ARBMode <Mode>

DESCRIPTION This command is used to set or query the working mode of the ARB waveform

COMMAND SYNTAX [:SOURce]:<channel>:ARBMode <mode>

<channel>:={C1,C2}.

<mode>:={AFG,AWG}.

QUERY SYNTAX [:SOURce]:<channel>:ARBMode?

<channel>:={C1,C2}.

EXAMPLE

Set CH1 arb to AFG mode:

:C1:ARBMode AFG

Read the mode of CH1:

:C1:ARBMode?

Return:

AWG

3.32.2 [:SOURce]:<channel>:SEQuence <switch>

DESCRIPTION This command is used to set (query) the output status of the sequence

COMMAND SYNTAX [:SOURce]:<channel>:SEQuence <switch>

<channel>:={C1,C2}.

<switch>:={0,1}or{ON,OFF}.

QUERY SYNTAX [:SOURce]:<channel>:SEQuence?
 <channel>:={C1,C2}.

EXAMPLE Turn on the sequence output of channel 1
 :*C1:SEQuence ON*
 Read the sequence output status of channel 1
 :*C1:SEQuence?*

 Return:
 ON

3.32.3 [:SOURce]:<channel>:SEQuence:BURSt <count>

DESCRIPTION This command is used to set (query) the number of cycles of each output waveform when the sequence is in single output mode

COMMAND SYNTAX [:SOURce]:<channel>:SEQuence:BURSt <count>

 <channel>:={C1,C2,DIG}.
 <count>:={1 to 65535}.

QUERY SYNTAX [:SOURce]:<channel>:SEQuence:BURSt?
 <channel>:={C1,C2,DIG}.

EXAMPLE Set channel 1 sequence to output 2 cycles each time in single output mode
 :*C1:SEQuence:BURSt 2*
 Query the number of cycles of each output waveform of channel 1 sequence in single output mode
 :*C1:SEQuence:BURSt?*

 Return:
 2

3.32.4 [:SOURce]:<channel>:SEQUence:RMODE <mode>

DESCRIPTION	This command is used to set (query) the running mode of the sequence
COMMAND SYNTAX	<pre>[:SOURce]:<channel>:SEQUence:RMODE <mode></pre> <p><channel>:={C1,C2}.</p> <p><mode>:={CONT,TCON,BURS,STEP,ADV}.</p>
QUERY SYNTAX	<pre>[:SOURce]:<channel>:SEQUence:RMODE?</pre> <p><channel>:={C1,C2}.</p>
EXAMPLE	<p>Set the operation mode of channel 1 sequence to continuous operation</p> <pre><i>:C1:SEQUence:RMODE CONT</i></pre> <p>Query the operation mode of channel 1 sequence</p> <pre><i>:C1:SEQUence:RMODE?</i></pre> <p>Return:</p> <pre><i>CONT</i></pre>

3.32.5 [:SOURce]:<channel>:TRIGger[:SEQUence]:SOURce

DESCRIPTION	This command is used to set (query) the trigger mode when the sequence runs
COMMAND SYNTAX	<pre>[:SOURce]:<channel>:TRIGger:SOURce <src></pre> <p><channel>:={C1,C2}.</p> <p><src>:={MAN,TIME,EXT}.</p>
QUERY SYNTAX	<pre>[:SOURce]:<channel>:TRIGger:SOURce?</pre> <p><channel>:={C1,C2}.</p>

EXAMPLE Set the trigger mode of channel 1 sequence to external trigger
:C1:TRIGger:SOURce EXT

Query the trigger mode of channel 1 sequence
:C1:TRIGger:SOURce?

Return:
EXT

3.32.6 [:SOURce]:<channel>:TRIGger[:SEQuence][:IMMediate]

DESCRIPTION This command immediately triggers a sequence output

COMMAND SYNTAX [:SOURce]:<channel>:TRIGger
 <channel>:={C1,C2}.

EXAMPLE Immediately trigger the sequence output of channel 1
:C1:TRIGger

3.32.7 [:SOURce]:<channel>:TRIGger:TIMer

DESCRIPTION This command is used to set (query) the time interval triggered by the timer of the sequence

COMMAND SYNTAX [:SOURce]:<channel>:TRIGger:TIMer <time>
 <channel>:={C1,C2}.

QUERY SYNTAX [:SOURce]:<channel>:TRIGger:TIMer?
 <channel>:={C1,C2}.

EXAMPLE Set the timer trigger interval of channel 1 sequence to 1ms
:C1:TRIGger:TIMer 0.001

Query the time interval triggered by the timer of channel 1 sequence

:C1:TRIGger:TiMer?

Return:

"0.001"

3.32.8 [:SOURce]:<channel>:TRIGger[:SEQuence]:SLOPe

DESCRIPTION This command is used to set (query) the trigger edge of the external trigger of the sequence

COMMAND SYNTAX [:SOURce]:<channel>:TRIGger:SLOPe <slope>

<channel>:={C1,C2}.

<slope>:={RISe,FALL}.

QUERY SYNTAX [:SOURce]:<channel>:TRIGger:SLOPe?

<channel>:={C1,C2}.

EXAMPLE Set the trigger polarity of the external trigger of channel 1 sequence as the rising edge

:C1:TRIGger:SLOPe RISe

Query trigger polarity of the external trigger of channel 1 sequence

:C1:TRIGger:SLOPe?

Return:

RISe

3.32.9 [:SOURce]:<channel>:SEQUence:COUNT

DESCRIPTION	This command is used to set (query) the total number of segments of the sequence
COMMAND SYNTAX	<code>[:SOURce]:<channel>:SEQUence:COUNT <count></code> <code><channel>:={C1,C2}.</code>
QUERY SYNTAX	<code>[:SOURce]:<channel>:SEQUence:COUNT?</code> <code><channel>:={C1,C2}.</code>
EXAMPLE	Set channel 1 as a sequence of 10 segments <i><code>:C1:SEQUence:COUNT 10</code></i> Query the total number of segments of channel 1 sequence waveform <i><code>:C1:SEQUence:COUNT?</code></i> Return: <i><code>10</code></i>
NOTE	Count= {1 to 1024}

3.32.10 [:SOURce]:<channel>:SEQUence:DEFAUlt

DESCRIPTION	This command is used to set (query) sequence waveform parameters as default values
COMMAND SYNTAX	<code>[:SOURce]:<channel>:SEQUence:DEFAUlt</code> <code><channel>:={C1,C2}.</code>
EXAMPLE	Set the sequence waveform parameters of channel 1 as the default setting <i><code>:C1:SEQUence:DEFAUlt</code></i>

3.32.11 [:SOURce]:<channel>:SEQuence:NEW

DESCRIPTION	This command is used to create a new sequence waveform
COMMAND SYNTAX	<pre>[:SOURce]:<channel>:SEQuence:NEW <segment number> <channel>:={C1,C2}. <segment number>:= Number of segments to be created</pre>
EXAMPLE	Create a new 10 segment waveform for the sequence of channel 1 <pre>:C1:SEQuence:NEW 10</pre>
NOTE	segment number = {1 to 1024}

3.32.12 [:SOURce]:<channel>:SEQuence:SEGMent<x>:WAVeform

DESCRIPTION	This command is used to set (query) the waveform of a certain segment of the sequence through the waveform name
COMMAND SYNTAX	<pre>[:SOURce]:<channel>:SEQuence:SEGMent<x>:WAVeform <name> <channel>:={C1,C2}. <x>:=segment number <name>:=waveform name. See section 3.33.5 for available waveform names</pre>
QUERY SYNTAX	<pre>[:SOURce]:<channel>:SEQuence:SEGMent<x>:WAVeform? <channel>:={C1,C2}. <x>:= segment number</pre>
EXAMPLE	Set the waveform of the third segment of channel 1 sequence as stairup

:C1:SEquence:SEGMent3:WAVeform stairup

Query the waveform of the third segment of channel 1 sequence
(return the waveform name)

:C1:SEquence:SEGMent3:WAVeform?

Return:

stairup

NOTE segment number = {1 to 1024}

3.32.13 [:SOURce]:<channel>:SEquence:SEGMent<x>:REPeat:COUNT

DESCRIPTION This command is used to set (query) the repetition times of a certain segment waveform of the sequence

COMMAND SYNTAX [:SOURce]:<channel>:SEquence:SEGMent<x>:REPeat:COUNT
<count>

<channel>:={C1,C2}.

<x>:=segment number

<count>:= The maximum value is related to the waveform length of this segment and the total length of other segments.

QUERY SYNTAX [:SOURce]:<channel>:SEquence:SEGMent<x>:REPeat:COUNT?

<channel>:={C1,C2}.

<x>:= segment number

EXAMPLE Set the waveform of the third segment of the channel 1 sequence to repeat twice

:C1:SEquence:SEGMent3:REPeat:COUNT 2

Query the waveform repetition times of the third segment of

channel 1 sequence
:C1:SEquence:SEGMent3:REPeat:COUnT?
 Return:
 2

NOTE segment number = {1 to 1024}

3.32.14 [:SOURce]:<channel>:SEQuence:SEGMent<x>:AMPlitude

DESCRIPTION This command is used to set (query) the waveform amplitude of a certain segment of the sequence

COMMAND SYNTAX [:SOURce]:<channel>:SEQuence:SEGMent<x>:AMPlitude <amp>

<channel>:={C1,C2}.
 <x>:= segment number
 <amp>:={0 to 24Vpp}

QUERY SYNTAX [:SOURce]:<channel>:SEQuence:SEGMent<x>:AMPlitude?
 <channel>:={C1,C2}.
 <x>:= segment number

EXAMPLE Set the amplitude of the third segment waveform of channel 1 sequence to 2Vpp

:C1:SEQuence:SEGMent3:AMPlitude 2

Query the amplitude of the waveform of the third segment of channel 1 sequence

:C1:SEQuence:SEGMent3:AMPlitude?

Return:
 2

NOTE segment number = {1 to 1024}

3.32.15 [:SOURce]:<channel>:SEQuence:SEGMENT<x>:OFFset

DESCRIPTION	This command is used to set (query) the waveform offset of a certain segment of the sequence
COMMAND SYNTAX	<pre>[:SOURce]:<channel>:SEQuence:SEGMENT<x>:OFFset <offset></pre> <p><channel>:={C1,C2}. <x>:= segment number <offset>:={-12V to 12V}</p>
QUERY SYNTAX	<pre>[:SOURce]:<channel>:SEQuence:SEGMENT<x>:OFFset?</pre> <p><channel>:={C1,C2}. <x>:= segment number</p>
EXAMPLE	<p>Set the offset of the third segment waveform of channel 1 sequence to 2Vdc</p> <pre><i>:C1:SEQuence:SEGMENT3:OFFset 2</i></pre> <p>Query the offset of the third segment waveform of channel 1 sequence</p> <pre><i>:C1:SEQuence:SEGMENT3:OFFset?</i></pre> <p>Return:</p> <pre><i>2</i></pre>
NOTE	segment number = {1 to 1024}

3.32.16 [:SOURce]:<channel>:SEQuence:SEGMent<x>:VOLTage:HIGH

DESCRIPTION	This command is used to set (query) the high-level value of the waveform of a certain segment of the sequence
COMMAND SYNTAX	<pre>[:SOURce]:<channel>:SEQuence:SEGMent<x>:VOLTage:HIGH <highLevel></pre> <p><channel>:={C1,C2}. <x>:= segment number <highLevel>:={lowLevel to 12V}</p>
QUERY SYNTAX	<pre>[:SOURce]:<channel>:SEQuence:SEGMent<x>:VOLTage:HIGH?</pre> <p><channel>:={C1,C2}. <x>:= segment number</p>
EXAMPLE	<p>Set the high level of the third segment waveform of channel 1 sequence to 10V</p> <pre><i>:C1:SEQuence:SEGMent3:VOLTage:HIGH 10</i></pre> <p>Query the high-level value of the waveform of the third segment of the channel 1 sequence</p> <pre><i>:C1:SEQuence:SEGMent3:VOLTage:HIGH?</i></pre> <p>Return:</p> <pre><i>10</i></pre>
NOTE	segment number = {1 to 1024}

3.32.17 [:SOURce]:<channel>:SEQuence:SEGMent<x>:VOLTage: LOW

DESCRIPTION	This command is used to set (query) the low-level value of the waveform of a certain segment of the sequence
COMMAND SYNTAX	<pre>[:SOURce]:<channel>:SEQuence:SEGMent<x>:VOLTage:LOW <lowLevel></pre> <p><channel>:={C1,C2}. <x>:= segment number <lowLevel>:={-12V to highLevel}</p>
QUERY SYNTAX	<pre>[:SOURce]:<channel>:SEQuence:SEGMent<x>:VOLTage:LOW?</pre> <p><channel>:={C1,C2}. <x>:= segment number</p>
EXAMPLE	<p>Set the low level of the third segment waveform of channel 1 sequence to 10V</p> <pre><i>:C1:SEQuence:SEGMent3:VOLTage:LOW 10</i></pre> <p>Query the low-level value of the third segment waveform of channel 1 sequence</p> <pre><i>:C1:SEQuence:SEGMent3:VOLTage:LOW?</i></pre> <p>Return:</p> <pre><i>10</i></pre>
NOTE	segment number = {1 to 1024}

3.32.18 [:SOURce]:<channel>:SEQUence:SEGMent<x>:LENGth

DESCRIPTION This command is used to set (query) the length of the waveform of a certain segment of the sequence

COMMAND SYNTAX [:SOURce]:<channel>:SEQUence:SEGMent<x>:LENGth <len>

<channel>:={C1,C2}.
<x>:= segment number
<len>:= It will be automatically truncated to an integer multiple of 16

QUERY SYNTAX [:SOURce]:<channel>:SEQUence:SEGMent<x>:LENGth?

<channel>:={C1,C2}.
<x>:= segment number

EXAMPLE Set the length of the waveform of the third segment of the channel 1 sequence to 16384

```
:C1:SEQUence:SEGMent3:LENGth 16384
```

Query the length of the waveform of the third segment of the channel 1 sequence

```
:C1:SEQUence:SEGMent3:LENGth?
```

Return:
16384

NOTE segment number = {1 to 1024}

3.32.19 [:SOURce]:<channel>:SEQuence:SEGMent<x>:DELEte

DESCRIPTION	This command is used to delete a segment in the sequence waveform
COMMAND SYNTAX	<pre>[:SOURce]:<channel>:SEQuence:SEGMent<x>:DELEte</pre> <pre><channel>:={C1,C2}.</pre> <pre><x>:= segment number</pre>
EXAMPLE	Delete the waveform of the third segment in the channel 1 sequence <i>C1:SEQuence:SEGMent3:DELEte</i>
NOTE	segment number = {1 to 1024}

3.32.20 [:SOURce]:<channel>:SEQuence:SEGMent<x>:INSErt

DESCRIPTION	This command is used to insert a new segment after a certain segment in the sequence waveform
COMMAND SYNTAX	<pre>[:SOURce]:<channel>:SEQuence:SEGMent<x>:INSErt</pre> <pre><channel>:={C1,C2}.</pre> <pre><x>:= segment number</pre>
EXAMPLE	Insert a new segment after the third segment of the channel 1 sequence <i>:C1:SEQuence:SEGMent3:INSErt</i>
NOTE	segment number = {1 to 1024}

3.32.21 [:SOURce]:<channel>:SEQUence:STATe

DESCRIPTION	This command is used to set (query) the running status of the sequence
COMMAND SYNTAX	<pre>[:SOURce]:<channel>:SEQUence:STATe <state></pre> <p><channel>:={C1,C2}.</p> <p><state>:={RUN,STOP} or {ON,OFF}</p>
QUERY SYNTAX	<pre>[:SOURce]:<channel>:SEQUence:STATe?</pre> <p><channel>:={C1,C2}.</p>
EXAMPLE	<p>Set the status of channel 1 sequence to "run"</p> <pre><i>:C1:SEQUence:STATe RUN</i></pre> <p>Query the status of channel 1 sequence</p> <pre><i>:C1:SEQUence:STATe?</i></pre> <p>Return:</p> <pre><i>RUN</i></pre>

3.32.22 [:SOURce]:<channel>:SEQUence:SCALe

DESCRIPTION	This command is used to set (query) the output amplitude of the sequence
COMMAND SYNTAX	<pre>[:SOURce]:<channel>:SEQUence:SCALe <scale></pre> <p><channel>:={C1,C2}.</p> <p><scale>:={0.01 to 1}</p>
QUERY SYNTAX	<pre>[:SOURce]:<channel>:SEQUence:SCALe?</pre> <p><channel>:={C1,C2}.</p>

EXAMPLE Set the output amplitude of channel 1 sequence to 80%
:C1:SEQuence:SCALe 0.8

Query the output amplitude of channel 1 sequence
:C1:SEQuence:SCALe?

Return:
0.8

3.32.23 [:SOURce]:<channel>:SEQuence:INCReasing

DESCRIPTION This command is used to set (query) the interpolation method of the sequence

COMMAND SYNTAX [:SOURce]:<channel>:SEQuence:INCReasing <mode>

<channel>:={C1,C2}.

<mode>:={INT,ZERo,HLAS,DUPL}

QUERY SYNTAX [:SOURce]:<channel>:SEQuence:INCReasing?
<channel>:={C1,C2}.

EXAMPLE Set the interpolation mode of channel 1 sequence to linear interpolation

C1:SEQuence:INCReasing INT

Query the interpolation mode of channel 1 sequence
C1:SEQuence:INCReasing?

Return:
INT

3.32.24 [:SOURce]:<channel>:SEQuence:DECReasing

DESCRIPTION	This command is used to set (query) the sampling method of the sequence
COMMAND SYNTAX	<pre>[:SOURce]:<channel>:SEQuence:DECReasing <mode></pre> <p><channel>:={C1,C2}.</p> <p><mode>:={DECI,CTAi,CHEa}</p>
QUERY SYNTAX	<pre>[:SOURce]:<channel>:SEQuence:DECReasing?</pre> <p><channel>:={C1,C2}.</p>
EXAMPLE	<p>Set the sampling method of channel 1 sequence to linear sampling</p> <pre><i>:C1:SEQuence:DECReasing DECI</i></pre> <p>Query the sampling method of channel 1 sequence</p> <pre><i>:C1:SEQuence:DECReasing?</i></pre> <p>Return:</p> <pre><i>DECI</i></pre>

3.32.25 [:SOURce]:<channel>:SEQUence:RECall

DESCRIPTION This command is used to load sequence waveforms from a file

COMMAND SYNTAX [:SOURce]:<channel>:SEQUence:RECall <path>

<channel>:={C1,C2}.

<path>:= Complete path of waveform

EXAMPLE

From file sequence.csv loading sequence waveform

:C1:SEQUence:RECall "Local/sequence.awg"

:C1:SEQUence:RECall "U-disk0/sequence.awg"

:C1:SEQUence:RECall "net_storage/sequence.awg"

NOTE

The specific path refers to the path in the file manager

3.32.26 [:SOURce]:<channel>:SEQUence:SAVe

DESCRIPTION This command is used to save the sequence waveform to a file

COMMAND SYNTAX [:SOURce]:<channel>:SEQUence:SAVe<path>

<channel>:={C1,C2}.

<path>:= Complete path of waveform

EXAMPLE

Save the sequence waveform to wave1.csv

:C1:SEQUence:SAVe "Local/sequence.awg"

:C1:SEQUence:SAVe "U-disk0/sequence.awg"

:C1:SEQUence:SAVe "net_storage/sequence.awg"

NOTE

The specific path refers to the path in the file manager

3.33 [[:SOURce]:]Digital Channel Command

3.33.1 DIG:SRATe

DESCRIPTION This command is used to set (query) the bit rate of the digital channel

COMMAND SYNTAX [[:SOURce]:]DIG:SRATe <value>
<value>:={0 to 1000000000}

QUERY SYNTAX [[:SOURce]:]DIG:SRATe?

EXAMPLE Set the bit rate of the digital channel to 100Mbps
:DIG:SRATe 100000000
Query bit rate of digital channel
:DIG:SRATe?
Return:
100000000

3.33.2 [[:SOURce]:]DIG:PERiod

DESCRIPTION This command is used to set (query) the period of the digital channel

COMMAND SYNTAX [[:SOURce]:]DIG:PERiod <value>
<value>:={1ns to 1Ks}

QUERY SYNTAX [[:SOURce]:]DIG:PERiod?

EXAMPLE Set the period of the digital channel to 10 ns
:DIG:PERiod 0.00000001
Query the period of the digital channel
:DIG:PERiod?
Return:
0.00000001

3.33.3 [:SOURce]:DIG:CHANnel<x>:STATe

DESCRIPTION This command is used to set (query) the status of a digital channel

COMMAND SYNTAX [:SOURce]:DIG:CHANnel<x>:STATe <value>
<X>:={1 to 16}
<value>:={0 or 1} or {off or on}

QUERY SYNTAX [:SOURce]:DIG:CHANnel<index>:STATe?

EXAMPLE Set channel 2 to on
:DIG:CHANnel2:STATe 1
Query the status of digital channel 2
:DIG:CHANnel2;STATe?
Return:
1

3.33.4 [:SOURce]:DIG:OUTPut

DESCRIPTION This command is used to set (query) the output status of the digital channel

COMMAND SYNTAX [:SOURce]:DIG:OUTPut <value>
<value>:={0 or 1} or {off or on}

QUERY SYNTAX [:SOURce]:DIG:OUTPut?

EXAMPLE Turn on the digital channel output
:DIG:OUTPut 1
Query the output status of the digital channel
:DIG:OUTPut?
Return:
1

3.33.5 [:SOURce]:DIG:WAVeform

DESCRIPTION This command is used to set (query) the data source of the digital channel through the waveform name

COMMAND SYNTAX [:SOURce]:DIG:WAVeform <name>

<name>:= The name of the built-in waveform, or the complete path of the waveform

QUERY SYNTAX [:SOURce]:DIG:WAVeform?

EXAMPLE Set the data source of the digital channel as sine
:DIG:WAVeform sine

Query the digital channel data source
:DIG:WAVeform?

Return:
"sine"

sine	noise	erfc	erfcinv
stairup	stairdn	erfinv	laguerre
stairud	ppulse	legend	versiera
npulse	trapezia	weibull	lognormal
upramp	dnramp	laplace	maxwell
exp_fall	exp_rise	rayleigh	cauchy
logfall	logrise	cosh	cosint
sqrt	root3	coth	csch
x^2	x^3	sech	sinh
sinc	gussian	sinint	tanh
dlorentz	haversine	acosh	asech
lorentz	gauspuls	asinh	atanh

gmonopuls	tripuls	acsch	acoth
cardiac	quake	bartlett	bohmanwin
chirp	twotone	chebwin	flattopwin
snr	digit_clock	parzenwin	taylorwin
digit_counter	digit_zero	tukeywin	square_duty01
hamming	hanning	square_duty02	square_duty04
kaiser	blackman	square_duty06	square_duty08
gausswin	triang	square_duty10	square_duty12
blackmanharris	barthannwin	quare_duty14	square_duty16
tan	cot	square_duty18	square_duty20
sec	csc	square_duty22	square_duty24
asin	acos	square_duty26	square_duty28
atan	acot	square_duty30	square_duty32
square	sinetra	square_duty34	square_duty36
sinever	ampalt	square_duty38	square_duty40
attalt	roundhalf	square_duty42	square_duty44
roundspm	blaseiwave	square_duty46	square_duty48
dampedosc	swingosc	square_duty50	square_duty52
discharge	pahcur	square_duty54	square_duty56
combin	scr	square_duty58	square_duty60
butterworth	chebyshev1	square_duty62	square_duty64
chebyshev2	tv	square_duty66	square_duty68
voice	surge	square_duty70	square_duty72
radar	ripple	square_duty74	square_duty76
gamma	stepresp	square_duty78	square_duty80
bandlimited	cpulse	square_duty82	square_duty84
cwpulse	gatevibr	square_duty86	square_duty88
lfmpulse	mcnoise	square_duty90	square_duty92
am	fm	square_duty94	square_duty96
pfm	pm	square_duty98	square_duty99
pwm	eog	demo1_375pts	demo1_16kpts

eeg	emg	demo2_3kpts	demo2_16kpts
pulseilogram	resspeed	sine_harmonic2	sine_harmonic3
ecg1	ecg2	sine_harmonic4	sine_harmonic5
ecg3	ecg4	sine_harmonic6	sine_harmonic7
ecg5	ecg6	sine_harmonic8	sine_harmonic9
ecg7	ecg8	sine_harmonic10	sine_harmonic11
ecg9	ecg10	sine_harmonic12	sine_harmonic13
ecg11	ecg12	sine_harmonic14	sine_harmonic15
ecg13	ecg14	sine_harmonic16	digit_one
ecg15	lfpulse		
tens1	tens2		
tens3	airy		
besselj	bessely		
dirichlet	erf		

3.34 Virtual Key Command

DESCRIPTION This command is used to simulate pressing a key on the front panel.

COMMAND SYNTAX VirtualKEY VALUE,<value>,STATE,<state>

<value>:= {a Name or Index of the virtual keys from the table below}.

<state>:= {0,1}, where 1 is effective to virtual value, and 0 is useless.

Name	Indexes	Name	Indexes
KB_FUNC1	28	KB_NUMBER_4	52
KB_FUNC2	23	KB_NUMBER_5	53

KB_FUNC3	18	KB_NUMBER_6	54
KB_FUNC4	13	KB_NUMBER_7	55
KB_FUNC5	8	KB_NUMBER_8	56
KB_FUNC6	3	KB_NUMBER_9	57
KB_SINE	34	KB_POINT	46
KB_SQUARE	29	KB_NEGATIVE	43
KB_RAMP	24	KB_LEFT	44
KB_PULSE	19	KB_RIGHT	40
KB_NOISE	14	KB_UP	45
KB_ARB	9	KB_DOWN	39
KB_MOD	15	KB_OUTPUT1	153
KB_SWEEP	16	KB_OUTPUT2	152
KB_BURST	17	KB_KNOB_RIGHT	175
KB_WAVES	4	KB_KNOB_LEFT	177
KB_UTILITY	11	KB_KNOB_DOWN	176
KB_PARAMETER	5	KB_HELP	12
KB_STORE_RECALL	70	KB_CHANNEL	72
KB_NUMBER_0	48	KB_K	59
KB_NUMBER_1	49	KB_M	60
KB_NUMBER_2	50	KB_G	61
KB_NUMBER_3	51	KB_DIGITAL	20
KB_ENTER	58	KB_HOME	21
KB_AWG	29	KB_TOUCH	22
KB_IQ	30		

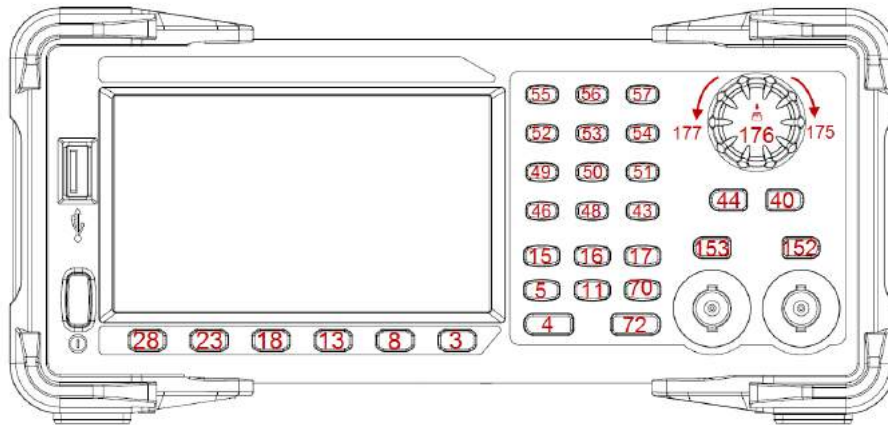

Keys and Indices on the SDG1000X/SDG2000X/SDG6000X/SDG6000X-E

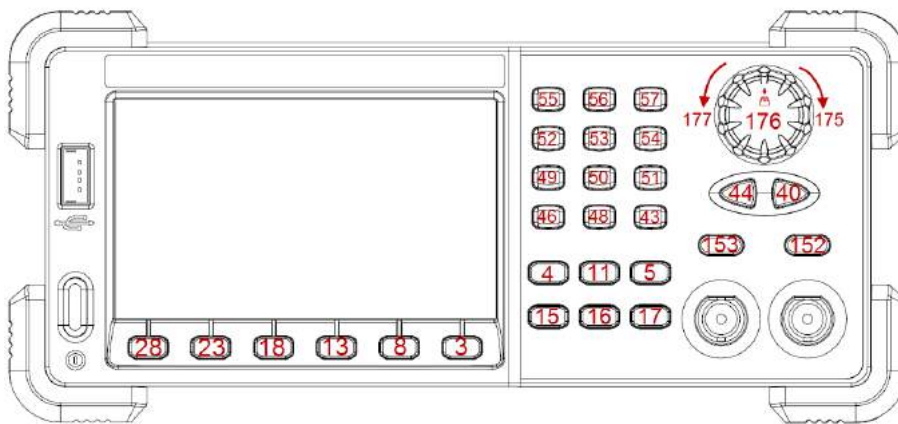

Keys and Indices on the SDG5000

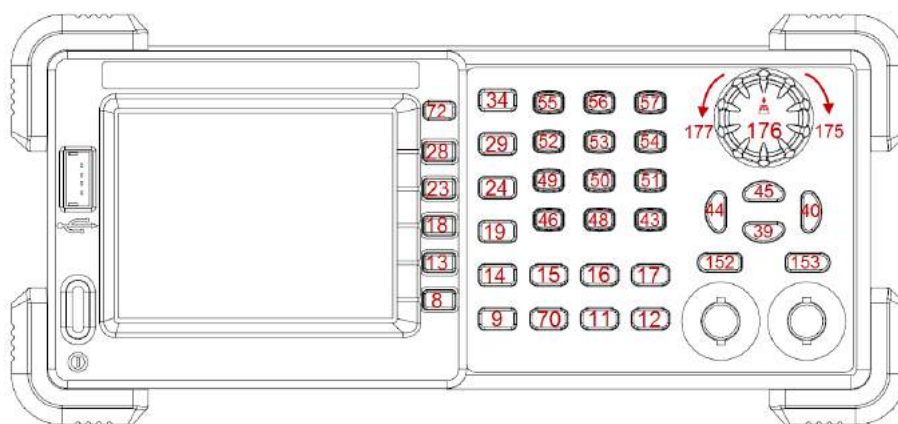

Keys and Indices on the SDG1000/SDG800

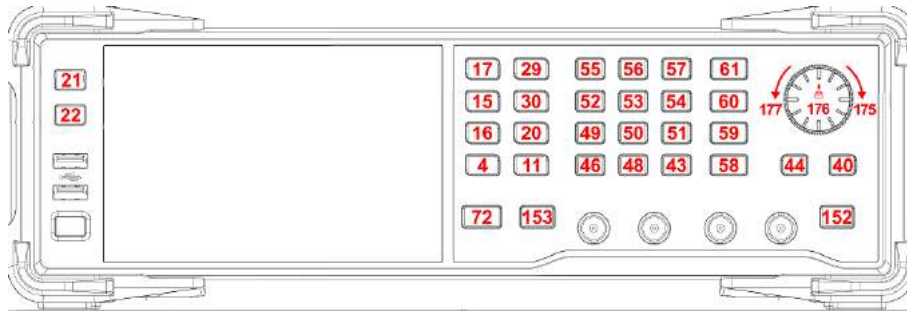

Keys and Indices on the SDG7000A

EXAMPLE

VKEY VALUE,15,STATE,1

VKEY VALUE,KB_SWEEP,STATE,1

Note: The table below shows the availability of some command parameters in each SDG series.

Parameter /command	SDG800	SDG1000	SDG2000X	SDG5000	SDG1000X	SDG6000X/X-E	SDG7000A
KB_FUNC6	no	no	yes	yes	yes	yes	no
KB_STORE_RECALL	yes	yes	yes	no	yes	yes	no
KB_HELP	yes	yes	no	no	no	no	no
KB_CHANNEL	no	yes	yes	no	yes	yes	yes
KB_SINE	yes	yes	no	no	no	no	no
KB_SQUARE	yes	yes	no	no	no	no	no
KB_RAMP	yes	yes	no	no	no	no	no
KB_PULSE	yes	yes	no	no	no	no	no
KB_NOISE	yes	yes	no	no	no	no	no
KB_ARB	yes	yes	no	no	no	no	no
KB_UP	yes	yes	no	no	no	no	no
KB_DOWN	yes	yes	no	no	no	no	no

3.35 IP Command

- DESCRIPTION** This command sets and gets the system IP address.
- COMMAND SYNTAX** SYSTem:COMMunicate:LAN:IPADdress
 "<parameter1>.<parameter2>.<parameter3>.<parameter4>"
- <parameter1>:={an integer value between 1 and 223}.
 <parameter2>:={an integer value between 0 and 255}.
 <parameter3>:={an integer value between 0 and 255}.
 <parameter4>:={an integer value between 0 and 255}.
- QUERY SYNTAX** SYSTem:COMMunicate:LAN:IPADdress?
- EXAMPLES** Set IP address to 10.11.13.203:
SYST:COMM:LAN:IPAD "10.11.13.203"
- Get the IP address:
SYST:COMM:LAN:IPAD?
- Return:
"10.11.13.203"

Note: The table below shows the availability of the command in each SDG series :

Parameter /command	SDG800	SDG1000	SDG2000X	SDG5000	SDG1000X	SDG6000X/X-E	SDG7000A
SYST:COMM:LAN:IPAD	no	no	yes	no	yes	yes	yes

3.36 Subnet Mask Command

DESCRIPTION	This command sets and gets the system subnet mask.
COMMAND SYNTAX	<p>SYSTem:COMMunicate:LAN:SMASk</p> <p>“<parameter1>.<parameter2>.<parameter3>.<parameter4>”</p> <p><parameter1>:={an integer value between 0 and 255}.</p> <p><parameter2>:={an integer value between 0 and 255}.</p> <p><parameter3>:={an integer value between 0 and 255}.</p> <p><parameter4>:={an integer value between 0 and 255}.</p>
QUERY SYNTAX	SYSTem:COMMunicate:LAN:SMASk?
EXAMPLES	<p>Set the subnet mask to 255.0.0.0:</p> <p><i>SYST:COMM:LAN:SMAS “255.0.0.0”</i></p> <p>Get the subnet mask:</p> <p><i>SYST:COMM:LAN:SMAS?</i></p> <p>Return:</p> <p><i>“255.0.0.0”</i></p>

Note: The table below shows the availability of the command in each SDG series.

Parameter /command	SDG800	SDG1000	SDG2000X	SDG5000	SDG1000X	SDG6000X/X-E	SDG7000A
SYST:COMM:LAN:SMAS	no	no	yes	no	yes	yes	yes

3.37 Gateway Command

- DESCRIPTION** This command sets and gets the system gateway.
- COMMAND SYNTAX** `SYSTem:COMMunicate:LAN:GATeway`
 “<parameter1>.<parameter2>.<parameter3>.<parameter4>”
- <parameter1>:={an integer value between 0 and 223}.
 <parameter2>:={an integer value between 0 and 255}.
 <parameter3>:={an integer value between 0 and 255}.
 <parameter4>:={an integer value between 0 and 255}.
- QUERY SYNTAX** `SYSTem:COMMunicate:LAN:GATeway?`
- EXAMPLES** Set Gateway to 10.11.13.5:
SYSTem:COMMunicate:LAN:GATeway “10.11.13.5”
- Get gateway:
SYSTem:COMMunicate:LAN:GATeway?
- Return:
“10.11.13.5”

Note: The table below shows the availability of the command in each SDG series.

Parameter /command	SDG800	SDG1000	SDG2000X	SDG5000	SDG1000X	SDG6000X/X-E	SDG7000A
SYST:COMM:LAN:GAT	no	no	yes	no	yes	yes	yes

3.38 Sampling Rate Command

DESCRIPTION	This command sets or gets the Arb mode, sampling rate, and interpolation method. The sampling rate and interpolation method can only be set when MODE is TARB.
COMMAND SYNTAX	<p><channel>:SampleRATE MODE,<mode>,VALUE, <sample rate>, INTER,<interpolation></p> <p><channel>:= <C1, C2>.</p> <p><mode>:= {DDS, TARB}, where TARB is TrueArb or <mode>:={AFG, AWG} (only SDG7000A)</p> <p><sample rate>:= sample rate. The unit is samples per second "Sa/s".</p> <p><interpolation>:= {LINE, HOLD, SINC, SINC27, SINC13}, where LINE is linear, and HOLD is zero-order hold. SINC, SINC27 and SINC13 are only for SDG6000X/X-E and SDG7000A</p>
QUERY SYNTAX	<channel>:SRATE?
EXAMPLES	<p>Get the sampling rate of CH1:</p> <p><i>C1:SRATE?</i></p> <p>Return:</p> <p><i>C1:SRATE MODE,DDS</i></p> <p>Set CH1 to TureArb mode:</p> <p><i>C1:SRATE MODE,TARB</i></p> <p>Set sampling rate of CH1 to 1000000Sa/s:</p> <p><i>C1:SRATE VALUE,1000000</i></p> <p>Set CH1 to TureArb mode and set interpolation to SINC13</p> <p><i>C1:SRATE MODE,TARB,INTER,SINC13</i></p>

Note: The table below shows the availability of the command and some parameters in each SDG series.

Parameter /command	SDG800	SDG1000	SDG2000X	SDG5000	SDG1000X	SDG6000X/X-E	SDG7000A
SRATE	no	no	yes	no	no	yes	yes
INTER	no	no	no	no	no	yes	yes

3.39 Harmonic Command

DESCRIPTION This command sets or gets the harmonic parameters. Only available when the basic wave is SINE.

COMMAND SYNTAX <channel>:HARMonic HARMSTATE,<state>,HARMTYPE,<type>,HARMORDER,<order>,<unit>,<value>,<phase>

<state>:= <ON, OFF>.

<type>:= <EVEN, ODD, ALL>.

<order>:= {1,2,...,M}, where M is the supported maximum order.

<unit>:= < HARMAMP, HARMDBC>.

<value>:= amplitude of specified harmonic. The range of valid values depends on the model. When <unit>= HARMAMP, the unit is volts, peak-to-peak "Vpp", and when <unit>= HARMDBC, the unit is "dBc".

<phase>:= {0~360}, the unit is "degree"

QUERY SYNTAX <channel>:HARMonic?
<channel> :={C1, C2}.

EXAMPLES Enable the harmonic function of CH1:

C1:HARM HARMSTATE,ON

Set the 2nd harmonic of CH1 to -6 dBc:

C1:HARM HARMORDER,2,HARMDBC,-6

Get the harmonic information of CH1:

C1:HARM?

Return:

*C1:HARM ,HARMSTATE,ON,HARMTYPE,EVEN,HARMORDER,2,
HARMAMP,2.004748935V,HARMDBC,-6dBc,HARMPHASE,0*

Note: The table below shows the availability of the command in each SDG series.

Parameter /command	SDG800	SDG1000	SDG2000X	SDG5000	SDG1000X	SDG6000X/X-E	SDG7000A
HARM	no	no	yes	no	yes	yes	yes

3.40 Waveform Combining Command

DESCRIPTION This command sets or gets the waveform combining parameters.

COMMAND SYNTAX <channel>:CoMBiNe <state>
<channel>:= {C1, C2}.

<state>:= {ON, OFF}.

QUERY SYNTAX <channel>:CoMBiNe?
<channel>:= {C1, C2}.

RESPONSE FORMAT <channel>:CMBN <state>

EXAMPLES Enable waveform combining for CH1:

C1:CMBN ON

Query the waveform combining state of CH2:

C2:CMBN?

Return:

C2:CMBN OFF

Note: The table below shows the availability of the command in each SDG series.

Parameter /command	SDG800	SDG1000	SDG2000X	SDG5000	SDG1000X	SDG6000X/X-E	SDG7000A
CMBN	no	no	yes	no	yes	yes	yes

3.41 Mode Select Command

DESCRIPTION	This command sets or gets the phase mode.
COMMAND SYNTAX	MODE <parameter> <parameter>:= {PHASELOCKED, INDEPENDENT}.
QUERY SYNTAX	MODE?
RESPONSE FORMAT	MODE <parameter>
EXAMPLE	Set the phase mode to INDEPENDENT: <i>MODE INDEPENDENT</i>

Note: The table below shows the availability of the command in each SDG series.

Parameter /command	SDG800	SDG1000	SDG2000X	SDG5000	SDG1000X	SDG6000X/X-E	SDG7000A
MODE	no	no	yes	no	yes	yes	yes

3.42 Multi-Device Sync

DESCRIPTION	This command set up synchronization between two or more instruments and achieve in-phase output
COMMAND SYNTAX	<p>CASCADE STATE,ON OFF,MODE,<MODE>,DELAY,<DELAY></p> <p><MODE>:={MASTER,SLAVE}</p> <p><DELAY>:={0-0.000025},UNIT=s, This parameter can only be set in slave mode</p>
QUERY SYNTAX	CASCADE?
RESPONSE FORMAT	<p>Return from SLAVE MODE :</p> <p>CASCADE STATE,ON,MODE,SLAVE,DELAY, <DELAY></p> <p>Return from MASTER mode :</p> <p>CASCADE STATE,ON,MODE,MASTER</p>
EXAMPLE	<p>Set the device as slave and the delay to 0.0000001s:</p> <p><i>CASCADE STATE,ON,MODE,SLAVE,DELAY,0.0000001</i></p>

3.43 IQ Commands

The table below shows the availability of IQ commands in each SDG series.

Parameter /command	SDG800	SDG1000	SDG2000X	SDG5000	SDG1000X	SDG6000X	SDG6000X-E	SDG7000A
IQ	no	no	no	no	no	yes	no	yes

3.43.1 IQ:WAVeinfo?

DESCRIPTION	This command queries the waveform information of I/Q.
COMMAND SYNTAX	<code>IQ:WAVeinfo?</code>
EXAMPLE	<p>Query current I/Q waveform information:</p> <p><i>IQ:WAVeinfo?</i></p> <p>Return:</p> <p><i>WAVE_INFO,SYMBOL_LENGTH,1024,OVER_SAMPLING,4,MODULATION,2ASK,FILTER_TYPE,RootCosine,FILTER_ALPHA,0.35</i></p>

3.43.2 :IQ:CENTerfreq

DESCRIPTION	This command sets the center frequency of the I/Q modulator.
COMMAND SYNTAX	<p><code>[:SOURce]:IQ:CENTerfreq <center_freq><unit></code></p> <p><center_freq>:= the center frequency. Refer to the datasheet for the range of valid values.</p> <p><unit>:= {Hz, kHz, MHz, GHz}. The default unit is Hertz "Hz".</p>
QUERY SYNTAX	<code>[:SOURce]:IQ:CENTerfreq?</code>
RESPONSE FORMAT	<center_freq> (expressed in Hz.)
EXAMPLE	<p>Set the center frequency to 1 kHz:</p> <p><i>:SOURce:IQ:CENTerfreq 1000Hz</i></p>

3.43.3 :IQ:SAMPLerate

DESCRIPTION	This command sets the I/Q sampling rate.
COMMAND SYNTAX	<code>[:SOURce]:IQ:SAMPLerate <sample_rate><unit></code> <sample_rate>:= sample rate. Refer to the datasheet for the range of valid values. <unit>:= {Hz, kHz, MHz, GHz}. The default unit is Hertz "Hz".
QUERY SYNTAX	<code>[:SOURce]:IQ:SAMPLerate?</code>
RESPONSE FORMAT	<sample_rate> (expressed in Hz.)
EXAMPLE	Set the sample rate to 100 kHz: <code><i>:IQ:SAMPLerate 100000</i></code> or: <code><i>:IQ:SAMP 100kHz</i></code>

3.43.4 :IQ:SYMBOLrate

DESCRIPTION	This command sets the I/Q symbol rate.
COMMAND SYNTAX	<code>[:SOURce]:IQ:SYMBOLrate <symb_rate><unit></code> <symb_rate>:= symbol rate. Refer to the datasheet for the range of valid values. <unit>:= {S/s, kS/s, MS/s}. The default unit is symbols-per-second "S/s".
QUERY SYNTAX	<code>[:SOURce]:IQ:SYMBOLrate?</code>
RESPONSE FORMAT	<symb_rate> (expressed in S/s.)
EXAMPLE	Set the symbol rate to 1 MS/s: <code><i>:IQ:SYMB 1MS/s</i></code>

3.43.5 :IQ:AMPLitude

DESCRIPTION	This command sets the I/Q amplitude.
COMMAND SYNTAX	<p>[[:SOURce]:]IQ:AMPLitude <amplitude><unit></p> <p><amplitude>:= amplitude. Refer to the datasheet for the range of valid values.</p> <p><unit>:= {Vrms, mVrms, dBm}. The default unit is volts, root-mean-square "Vrms".</p>
QUERY SYNTAX	[[:SOURce]:]IQ:AMPLitude?
RESPONSE FORMAT	<amplitude> (expressed Vrms.)
EXAMPLE	<p>Set the I/Q amplitude ($\sqrt{I^2+Q^2}$) to 0.2 Vrms:</p> <p><i>:IQ:AMPL 0.2</i></p>

3.43.6 :IQ:IQADjustment:GAIN

DESCRIPTION	This command adjusts the ratio of I to Q while preserving the composite.
COMMAND SYNTAX	<p>[[:SOURce]:]IQ:IQADjustment:GAIN <gain_ratio></p> <p><gain_ratio>:= Gain ratio of I to Q. The default unit is dB.</p>
QUERY SYNTAX	[[:SOURce]:]IQ:IQADjustment:GAIN?
RESPONSE FORMAT	<gain_ratio> (expressed in unit of dB.)
EXAMPLE	<p>Set the gain ratio of I/Q to 0.1dB:</p> <p><i>:IQ:IQADjustment:GAIN 0.1</i></p>

3.43.7 :IQ:IQADjustment:I OFFset

DESCRIPTION	This command adjusts the I channel offset value.
COMMAND SYNTAX	<code>[[:SOURce]:IQ:IQADjustment:I OFFset <offset><unit></code> <offset>:= I offset. <unit>:= {V, mV, uV}. The default unit is volts "V".
QUERY SYNTAX	<code>[[:SOURce]:IQ:IQADjustment:I OFFset?</code>
RESPONSE FORMAT	<offset> (expressed V.)
EXAMPLE	Set the I offset to 1 mV: <code><i>:IQ:IQADjustment:I OFFset 1mV</i></code>

3.43.8 :IQ:IQADjustment:Q OFFset

DESCRIPTION	This command adjusts the Q channel offset value.
COMMAND SYNTAX	<code>[[:SOURce]:IQ:IQADjustment:Q OFFset <offset><unit></code> <offset>:= Q offset. <unit>:= {V, mV, uV}. The default unit is volts "V".
QUERY SYNTAX	<code>[[:SOURce]:IQ:IQADjustment:Q OFFset?</code>
RESPONSE FORMAT	<offset> (expressed in V.)
EXAMPLE	Set the Q offset to -1 mV: <code><i>:IQ:IQAD:Q OFF -0.001V</i></code>

3.43.9 :IQ:IQADjustment:QSKew

DESCRIPTION	This command adjusts the phase angle (quadrature skew) between the I and Q vectors by increasing or decreasing the Q phase angle.
COMMAND SYNTAX	<code>[[:SOURce]:IQ:IQADjustment:QSKew <angle></code> <angle>:= angle. The unit is degree.
QUERY SYNTAX	<code>[[:SOURce]:IQ:IQADjustment:QSKew?</code>
RESPONSE FORMAT	<angle> (expressed in unit of degree.)
EXAMPLE	Set the Q angle to 1 degree: <i><code>:IQ:IQADjustment:QSKew 1.0</code></i>

3.43.10 :IQ:TRIGger:SOURce

DESCRIPTION	This command sets the I/Q trigger source.
COMMAND SYNTAX	<code>[[:SOURce]:IQ:TRIGger:SOURce <src></code> <src>:={INTernal,EXTernal,MANual}
QUERY SYNTAX	<code>[[:SOURce]:IQ:TRIGger:SOURce?</code>
RESPONSE FORMAT	<src>
EXAMPLE	Set the trigger source to INT: <i><code>:IQ:TRIGger:SOURce INTernal</code></i>

3.43.11 :IQ:WAVEload:BUILtin

DESCRIPTION This command selects I/Q waveform from the built in waveform list.

COMMAND SYNTAX [:SOURce]:IQ:WAVEload:BUILtin <wave_name>
 <wave_name>:= {A waveform name from the table below}.

QUERY SYNTAX [:SOURce]:IQ:WAVEload?

RESPONSE FORMAT BUILtin|USERstored <wave_name>

EXAMPLE Set the I/Q waveform to built-in 2ASK:

:IQ:WAVE:BUIL 2ASK

2ASK	4ASK	8ASK	BPSK	4PSK
8PSK	DBPSK	4DPSK	8DPSK	8QAM
16QAM	32QAM	64QAM	128QAM	256QAM

3.43.12 :IQ:WAVEload:USERstored

DESCRIPTION This command selects I/Q waveform from the user stored waveforms.

COMMAND SYNTAX Format1: [:SOURce]:IQ:WAVEload:USERstored "<wave_name>"
 <wave_name>:= { A waveform name from the user stored waveforms}.

Format2: [:SOURce]:IQ:WAVEload:USERstored<path>
 <Path>:= {waveform path from user storage (local, network storage, USB flash disk), including file name and suffix}.

QUERY SYNTAX [:SOURce]:IQ:WAVEload?

RESPONSE FORMAT BUILtin|USERstored <wave_name>

EXAMPLE1 Set the I/Q waveform to user stored UserIQ_1.arb:

:IQ:WAVEload:USERstored wave1.arb

EXAMPLE2 Set the I/Q waveform as the user's locally stored waveform wave1.arb:

:IQ:WAVEload:USERstored "wave1.arb"

Or: IQ:WAVEload:USERstored "Local/wave1.arb"

EXAMPLE3 Set the I / Q waveform to network storage waveform wave1.arb:

:IQ:WAVEload:USERstored "net_storage/wave/wave1.arb"

EXAMPLE4 Set the I / Q waveform to the U disk storage waveform wave1.arb:

:IQ:WAVEload:USERstored "U-disk0/ wave/wave1.arb"

Note1:

- (1) the path must be included in double quotation marks, for example: "net_storage/wave/wave1.Arb". Please refer to file manager for specific available paths.
- (2) If no path is specified, the default is the local path. If no suffix is added, the default is Wav suffix.

Note 2: the following table shows the availability of some commands in different SDG series.

Parameter /command	SDG800	SDG1000	SDG2000X	SDG5000	SDG1000X	SDG6000X	SDG6000X-E	SDG7000A
USERstored	no	no	no	no	no	Format1	no	Format2

3.43.13 :IQ:FrequencySampling

DESCRIPTION	This command sets the I/Q Frequency sampling rate.
COMMAND SYNTAX	<code>[:SOURce]:IQ: FrequencySampling <sampling></code> < sampling >:= {1000-1250000000}. The unit is Hz
QUERY SYNTAX	<code>[:SOURce]:IQ:FrequencySampling?</code> <code>[:SOURce]:IQ:FrequencySamplingLimit?</code>
RESPONSE FORMAT	<sampling> MAX,<max_sampling>,MIN,< min_sampling >
EXAMPLE	Set the I/Q frequency sampling to 2000000 Hz: <i><code>:IQ:FrequencySampling 2000000</code></i>

3.44 File Operation Commands

3.44.1 MMEMory:DELeTe

DESCRIPTION	This command deletes the file.
COMMAND SYNTAX	MMEMory:DELeTe <parameter> <parameter>:= "The path of the file".
QUERY SYNTAX	
RESPONSE FORMAT	
EXAMPLE	Delete a file whose path is "Local/1000pts.bin": <i>MMEMory:DELeTe "Local/1000pts.bin"</i>

3.44.2 MMEMory:RDIRectory

DESCRIPTION	This command deletes the directory.
COMMAND SYNTAX	MMEMory:RDIRectory <parameter> <parameter>:= "The path of the directory".
QUERY SYNTAX	
EXAMPLE	Delete a directory whose path is "Local/test": <i>MMEMory:RDIRectory "Local/test"</i>

3.44.3 MMEMory:MDIRectory

DESCRIPTION	This command creates a new directory.
COMMAND SYNTAX	MMEMory:MDIRectory <parameter> <parameter>:= "The path of the directory".

QUERY SYNTAX**EXAMPLE**

Create a directory whose path is "Local/test":

MMEMory:MDIRectory "Local/test"

3.44.4 MMEMory:CATalog**DESCRIPTION**

This command checks the files and the directories from the path or checks the file with specific type.

COMMAND SYNTAX

MMEMory:CATalog? <parameter>

<parameter>:= "The path of the directory".

MMEMory:CATalog:DATA:ARBitrary? <parameter>

<parameter>:= "The path of the directory".

MMEMory:CATalog:STATe:XMLanguage? <parameter>

<parameter>:= "The path of the directory".

QUERY SYNTAX**RESPONSE FORMAT**

remain space, used space

"File Name, File Type, File size"

EXAMPLE

Check the files and directories whose path is "Local/":

MMEMory:CATalog? "Local"

Check the files with ".arb" or ".ARB" postfix whose path is "Local/":

MMEMory:CATalog:DATA:ARBitrary? "Local"

Check the files with ".xml" or ".XML" postfix whose path is "Local/":

MMEMory:CATalog:STATe:XMLanguage? "Local"

3.44.5 MMEMemory:COPY

DESCRIPTION	This command copies a file or a directory .
COMMAND SYNTAX	MMEMemory:COPY <parameter> <parameter>:= "The path of the source", "The path that the file is about to pasted to".
QUERY SYNTAX	
EXAMPLE	Copy the file whose path is "Local/test/1000pts.bin" and paste to "Local/1000pts.bin" <i>MMEMemory:COPY "Local/test/1000pts.bin","Local/1000pts.bin"</i> Copy the directory whose path is "Local/src" and paste to "Local/copy" <i>MMEMemory:COPY "Local/src", "Local/copy"</i>

3.44.6 MMEMemory:MOVE

DESCRIPTION	This command movesthe file or the directory to a new location.
COMMAND SYNTAX	MMEMemory:MOVE<parameter> <parameter>:= "The path of the source", "The path of the source that is about to move to".
QUERY SYNTAX	
RESPONSE FORMAT	
EXAMPLE	Move the file whose path is "Local/test/1000pts.bin" to "Local/1000pts.bin" <i>MMEMemory:MOVE "Local/test/1000pts.bin","Local/1000pts.bin"</i> Move the directory whose path is "Local/src" to "Local/copy/paste" <i>MMEMemory:MOVE "Local/src", "Local/copy/"</i>

4 Programming Examples

This chapter gives some examples for the programmer. In these examples, you can see how to use VISA or sockets, in combination with the commands described above to control the generator. By following these examples, you can develop many more applications.

4.1 Examples of Using VISA

4.1.1 VC++ Example

Environment: Windows 7 32-bit, Visual Studio.

Description: Query the instrument information using "*IDN?" command over NI-VISA, with the access through USBTMC and TCP/IP separately.

Steps:

1. Open Visual Studio and create a new VC++ win32 console project.
2. Set the project environment to use the NI-VISA lib, there are two ways to specify NI-VISA, static or automatic:

a) Static:

Find the files visa.h, visatype.h, and visa32.lib in the NI-VISA installation path, copy them to the root path of the VC++ project, and add them to the project. In the project name.cpp file, add the following two lines:

```
#include "visa.h"

#pragma comment(lib,"visa32.lib")
```

b) Dynamic:

In "project---properties---c/c+---General---Additional Include Directories" set the value to the NI-VISA installation path (e.g. C:\Program Files\IVI Foundation\VISA\WinNT\include), as shown in the figure below:

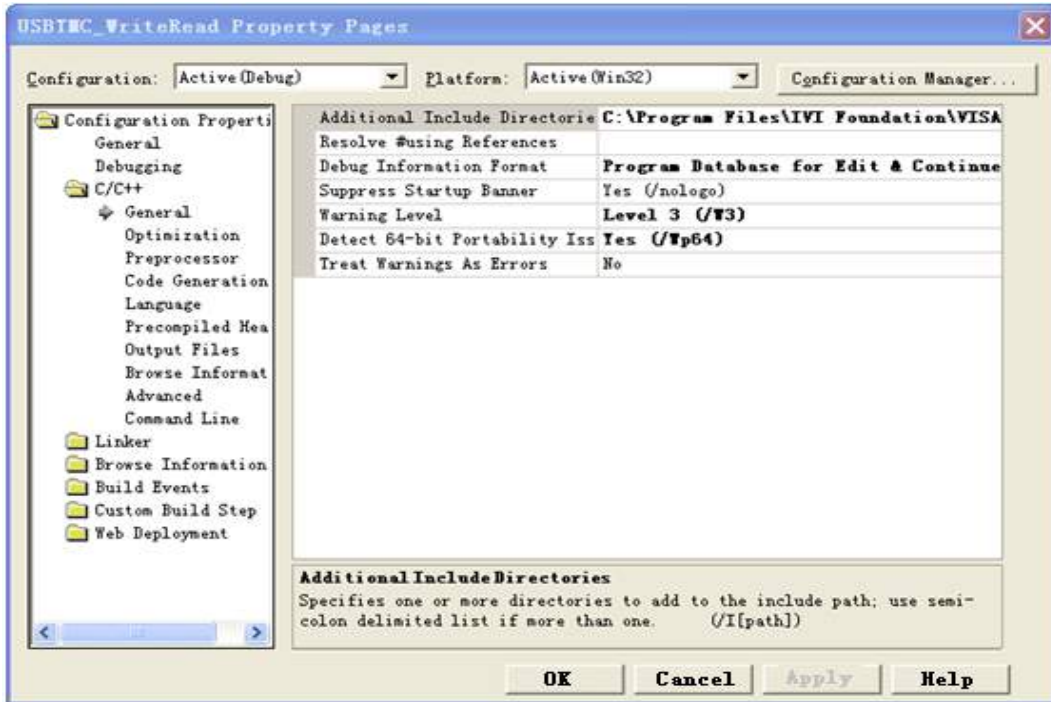

In "project---properties---Linker---General---Additional Library Directories " set the value to the NI-VISA installation path (e.g. C:\Program Files\IVI Foundation\VISAWinNT\include), as shown in the figure below:

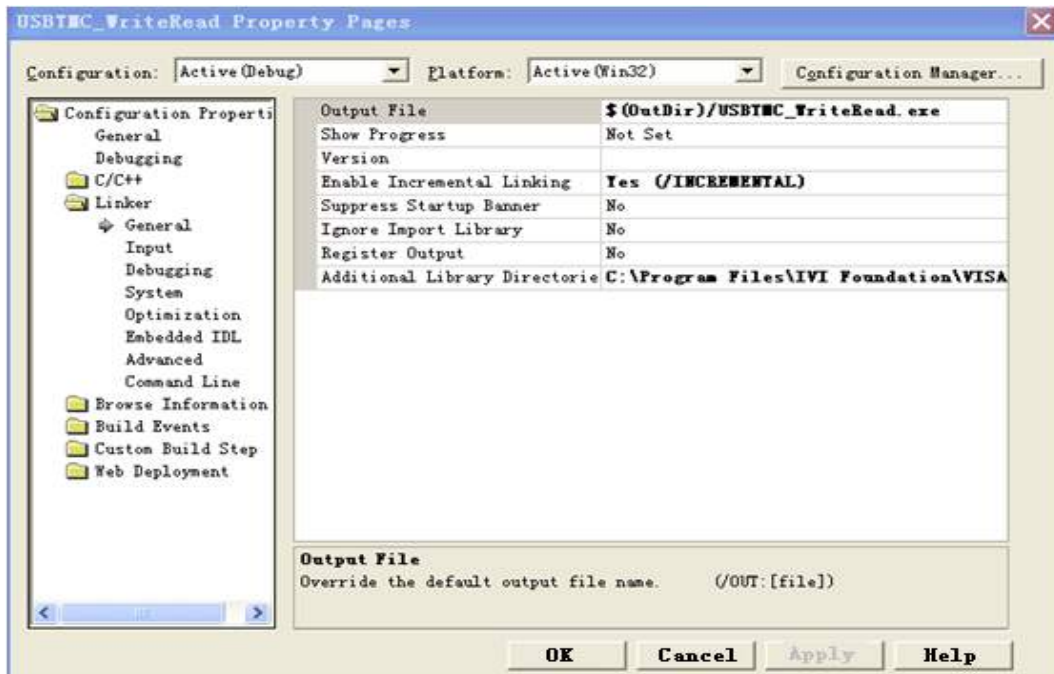

In "project---properties---Linker---Command Line---Additional" set the value to visa32.lib, as shown in the figure below:

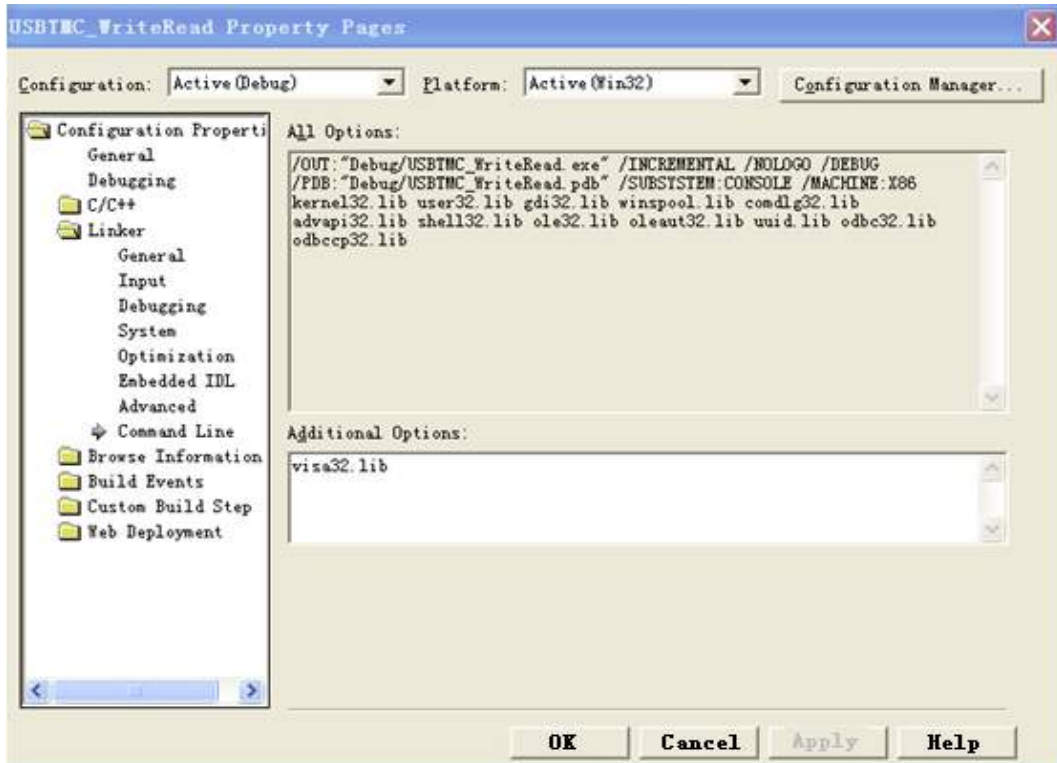

Include visa.h file in the projectname.cpp file:

```
#include <visa.h>
```

3. Coding:

a) USBTMC:

```
int Usbtmc_test()
{
    /* This code demonstrates sending synchronous read & write commands */
    /* to an USB Test & Measurement Class (USBTMC) instrument using      */
    /* NI-VISA                                                              */
    /* The example writes the "IDN?\n" string to all the USBTMC          */
    /* devices connected to the system and attempts to read back        */
    /* results using the write and read functions.                        */
    /* The general flow of the code is */
    /* Open Resource Manager */
}
```

```

/* Open VISA Session to an Instrument */
/* Write the Identification Query Using viPrintf */
/* Try to Read a Response With viScanf */
/* Close the VISA Session */

/*****/

ViSession defaultRM;

ViSession instr;

ViUInt32 numInstrs;

ViFindList findList;

ViStatus status;

char instrResourceString[VI_FIND_BUFLEN];

unsignedchar buffer[100];

int i;

/** First we must call viOpenDefaultRM to get the manager
 * handle. We will store this handle in defaultRM.*/

status=viOpenDefaultRM (&defaultRM);

if (status<VI_SUCCESS)

{

    printf ("Could not open a session to the VISA Resource Manager!\n");

    return status;

}

/* Find all the USB TMC VISA resources in our system and store the number of resources in the system in
numInstrs. */

status = viFindRsrc (defaultRM, "USB?*INSTR", &findList, &numInstrs, instrResourceString);

if (status<VI_SUCCESS)

{

    printf ("An error occurred while finding resources.\nPress 'Enter' to continue.");

    fflush(stdin);

    getchar();

```

```
        viClose (defaultRM);

        return  status;

    }

    /** Now we will open VISA sessions to all USB TMC instruments.

    * We must use the handle from viOpenDefaultRM and we must
    * also use a string that indicates which instrument to open.  This
    * is called the instrument descriptor.  The format for this string
    * can be found in the function panel by right-clicking on the
    * descriptor parameter. After opening a session to the
    * device, we will get a handle to the instrument which we
    * will use in later VISA functions.  The AccessMode and Timeout
    * parameters in this function are reserved for future
    * functionality.  These two parameters are given the value VI_NULL.*/
    for (i=0; i<int(numInstrs); i++)
    {

        if (i> 0)
        {

            viFindNext (findList, instrResourceString);

        }

        status = viOpen (defaultRM, instrResourceString, VI_NULL, VI_NULL, &instr);

        if (status<VI_SUCCESS)
        {

            printf ("Cannot open a session to the device %d.\n", i+1);

            continue;

        }

        /** * At this point we now have a session open to the USB TMC instrument.

        * We will now use the viPrintf function to send the device the string "*IDN?\n",
        * asking for the device's identification.  */

        char * cmand = "*IDN?\n";
```

```
status = viPrintf (instr, command);

if (status<VI_SUCCESS)
{
    printf ("Error writing to the device %d.\n", i+1);
    status = viClose (instr);
    continue;
}

/** Now we will attempt to read back a response from the device to
 * the identification query that was sent. We will use the viScanf
 * function to acquire the data.
 * After the data has been read the response is displayed.*/

status = viScanf(instr, "%t", buffer);

if (status<VI_SUCCESS)
{
    printf ("Error reading a response from the device %d.\n", i+1);
}
else
{
    printf ("\nDevice %d: %s\n", i+1 , buffer);
}

status = viClose (instr);

}

/** Now we will close the session to the instrument using
 * viClose. This operation frees all system resources. */

status = viClose (defaultRM);

printf("Press 'Enter' to exit.");

fflush(stdin);

getchar();
```

```
    return 0;
}

int _tmain(int argc, _TCHAR* argv[])
{
    Usbtmc_test();

    return 0;
}
```

Run result:

```
C:\Documents and Settings\Peter.Chen\My Documents\Visual Studio Proje...
Device 1: Siglent Technologies,SDG6032X,SDG6X03173458F,2.01.01.27R7
Press 'Enter' to exit.
```

b) TCP/IP:

```
int TCP_IP_Test(char *pIP)
{
    char outputBuffer[VI_FIND_BUFLLEN];

    ViSession defaultRM, instr;

    ViStatus status;

    /* First we will need to open the default resource manager. */
    status = viOpenDefaultRM (&defaultRM);

    if (status<VI_SUCCESS)
    {
        printf("Could not open a session to the VISA Resource Manager!\n");
    }
}
```

```
}

/* Now we will open a session via TCP/IP device */

char head[256] = "TCPIP0::";

char tail[] = "::INSTR";

strcat(head,pIP);

strcat(head,tail);

status = viOpen (defaultRM, head, VI_LOAD_CONFIG, VI_NULL, &instr);

if (status<VI_SUCCESS)

{

    printf ("An error occurred opening the session\n");

    viClose(defaultRM);

}

status = viPrintf(instr, "%dn?\n");

status = viScanf(instr, "%t", outputBuffer);

if (status<VI_SUCCESS)

{

    printf ("viRead failed with error code: %x \n",status);

    viClose(defaultRM);

}

else

{

    printf ("\nMessage read from device: %*s\n", 0,outputBuffer);

}

status = viClose (instr);

status = viClose (defaultRM);

printf("Press 'Enter' to exit.");

fflush(stdin);

getchar();

return 0;
```

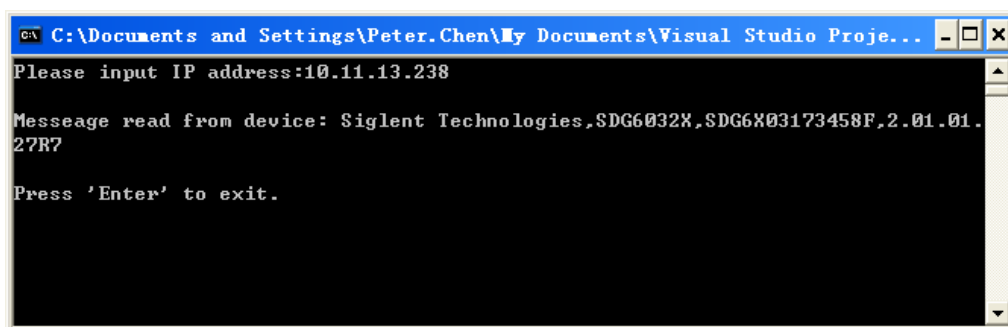

```
}  
  
int _tmain(int argc, _TCHAR* argv[])  
{  
    printf("Please input IP address:");  
  
    char ip[256];  
  
    fflush(stdin);  
  
    gets(ip);  
  
    TCP_IP_Test(ip);  
  
    return 0;  
}
```

Run result:

```
C:\Documents and Settings\Peter.Chen\My Documents\Visual Studio Proje...  
Please input IP address:10.11.13.238  
Message read from device: Siglent Technologies,SDG6032X,SDG6X03173458F,2.01.01.  
27R?  
Press 'Enter' to exit.
```

VB Example Environment: Windows 7 32-bit, Microsoft Visual Basic 6.0

Description: Query the instrument information using the “*IDN?” command over NI-VISA, via USBTMC and TCP/IP separately.

Steps:

1. Open Visual Basic, and build a standard application program project.
2. Set the project environment to use the NI-VISA lib: Click the Existing tab of Project>>Add Existing Item, search the visa32.bas file in the “include” folder under the NI-VISA installation path and add

the file, as shown in the figure below:

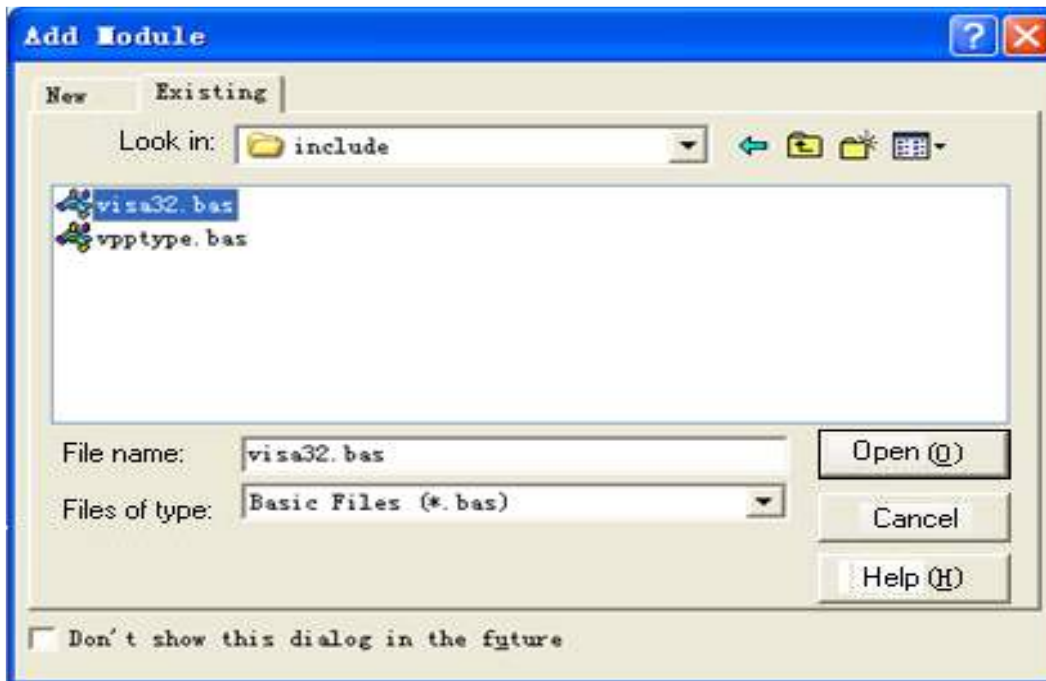

3. Coding:

a) USBTMC:

Private Function Usbtmc_test() As Long

```

' This code demonstrates sending synchronous read & write commands
' to an USB Test & Measurement Class (USBTMC) instrument using
' NI-VISA
' The example writes the "*IDN?\n" string to all the USBTMC
' devices connected to the system and attempts to read back
' results using the write and read functions.
' The general flow of the code is
'   Open Resource Manager
'   Open VISA Session to an Instrument
'   Write the Identification Query Using viWrite
'   Try to Read a Response With viRead
'   Close the VISA Session

```

```
Const MAX_CNT = 200
```

```
Dim defaultRM As Long
```

```
Dim instrsesn As Long
```

```
Dim numInstrs As Long
```

```
Dim findList As Long
```

```
Dim retCount As Long
```

```
Dim status As Long
```

```
Dim instrResourceString As String * VI_FIND_BUFLEN
```

```
Dim Buffer As String * MAX_CNT
```

```
Dim I As Integer
```

```
" First we must call viOpenDefaultRM to get the manager
```

```
" handle. We will store this handle in defaultRM.
```

```
status = viOpenDefaultRM(defaultRM)
```

```
If (status < VI_SUCCESS) Then
```

```
    resultTxt.Text = "Could not open a session to the VISA Resource Manager"
```

```
    Usbtmc_test = status
```

```
    Exit Function
```

```
End If
```

```
" Find all the USB TMC VISA resources in our system and store the
```

```
" number of resources in the system in numInstrs.
```

```
status = viFindRsrc(defaultRM, "USB?*INST", findList, numInstrs, instrResourceString)
```

```
If (status < VI_SUCCESS) Then
```

```
    resultTxt.Text = "An error occurred while finding resources"
```

```
    viClose(defaultRM)
```

```
    Usbtmc_test = status
```

```
    Exit Function
```

End If

“ Now we will open VISA sessions to all USB TMC instruments.
“ We must use the handle from viOpenDefaultRM and we must
“ also use a string that indicates which instrument to open. This
“ is called the instrument descriptor. The format for this string
“ can be found in the function panel by right-clicking on the
“ descriptor parameter. After opening a session to the
“ device, we will get a handle to the instrument which we
“ will use in later VISA functions. The AccessMode and Timeout
“ parameters in this function are reserved for future
“ functionality. These two parameters are given the value VI_NULL.

For i = 0 To numInstrs

 If (i > 0) Then

 status = viFindNext(findList, instrResourceString)

 End If

 status = viOpen(defaultRM, instrResourceString, VI_NULL, VI_NULL, instrsesn)

 If (status < VI_SUCCESS) Then

 resultTxt.Text = "Cannot open a session to the device" + CStr(i + 1)

 GoTo NextFind

 End If

“ At this point we now have a session open to the USB TMC instrument.
“ We will now use the viWrite function to send the device the string ""*IDN",
“ asking for the device's identification.

 status = viWrite(instrsesn, ""*IDN", 5, retCount)

 If (status < VI_SUCCESS) Then

 resultTxt.Text = "Error writing to the device"

 status = viClose(instrsesn)

```
        GoTo NextFind

    End If

    " Now we will attempt to read back a response from the device to
    " the identification query that was sent. We will use the viRead
    " function to acquire the data.

    " After the data has been read the response is displayed.

    status = viRead(instrsesn, Buffer, MAX_CNT, retCount)

    If (status < VI_SUCCESS) Then

        resultTxt.Text = ""Error reading a response from the device"" + CStr(i + 1)

    Else

        resultTxt.Text = ""Read from device:"" + CStr(i + 1) + """" + Buffer

    End If

    status = viClose(instrsesn)

Next i

    " Now we will close the session to the instrument using
    " viClose. This operation frees all system resources.

    status = viClose(defaultRM)

    Usbtmc_test = 0

End Function
```

b) TCP/IP:

```
Private Function TCP_IP_Test(ByVal ip As String) As Long

    Dim outputBuffer As String * VI_FIND_BUFLEN

    Dim defaultRM As Long

    Dim instrsesn As Long

    Dim status As Long
```

Dim count As Long

“ First we will need to open the default resource manager.

```
status = viOpenDefaultRM(defaultRM)
```

```
If (status < VI_SUCCESS) Then
```

```
    resultTxt.Text = “Could not open a session to the VISA Resource Manager”
```

```
    TCP_IP_Test = status
```

```
    Exit Function
```

```
End If
```

“ Now we will open a session via TCP/IP device

```
status = viOpen(defaultRM, “TCPIP0:” + ip + “::INST”, VI_LOAD_CONFIG, VI_NULL, instrsesn)
```

```
If (status < VI_SUCCESS) Then
```

```
    resultTxt.Text = “An error occurred opening the sessio”
```

```
    viClose(defaultRM)
```

```
    TCP_IP_Test = status
```

```
    Exit Function
```

```
End If
```

```
status = viWrite(instrsesn, “*IDN”, 5, count)
```

```
If (status < VI_SUCCESS) Then
```

```
    resultTxt.Text = “Error writing to the device”
```

```
End If
```

```
status = viRead(instrsesn, outputBuffer, VI_FIND_BUFLEN, count)
```

```
If (status < VI_SUCCESS) Then
```

```
    resultTxt.Text = “Error reading a response from the device” + CStr(i + 1)
```

```
Else
```

```
    resultTxt.Text = “read from device” + outputBuffer
```

```
End If
```

```
status = viClose(instrsesn)

status = viClose(defaultRM)

TCP_IP_Test = 0
```

End Function

c) Button control code:

```
Private Sub exitBtn_Click()

    End

End Sub

Private Sub tcpipBtn_Click()

    Dim stat As Long

    stat = TCP_IP_Test(ipTxt.Text)

    If (stat < VI_SUCCESS) Then

        resultTxt.Text = Hex(stat)

    End If

End Sub

Private Sub usbBtn_Click()

    Dim stat As Long

    stat = Usbtmc_test

    If (stat < VI_SUCCESS) Then

        resultTxt.Text = Hex(stat)

    End If

End Sub
```

Run result:

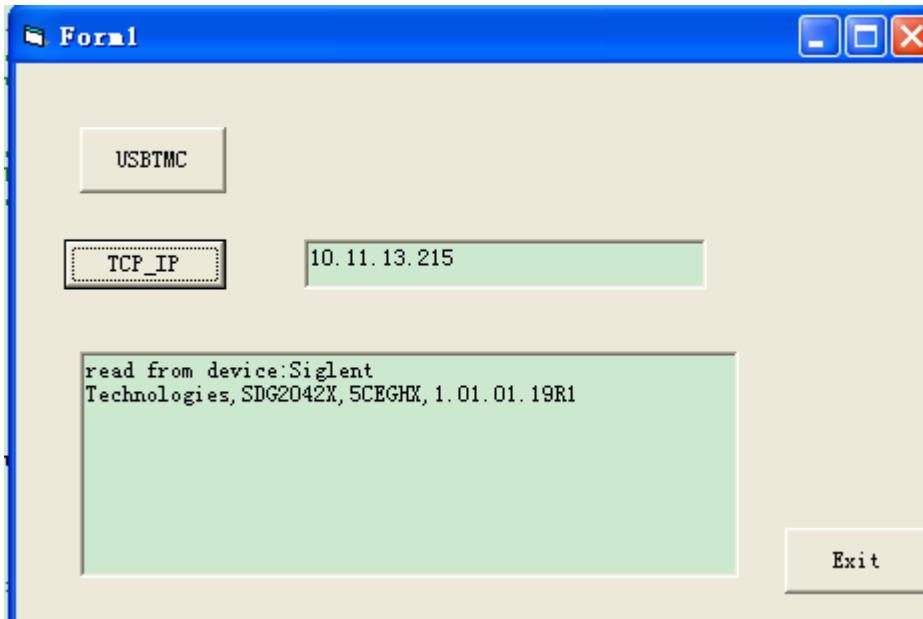

MATLAB Example **Environment:** Windows 7 32-bit, MATLAB R2013a

Description: Query the instrument information using the "*"IDN?" command over NI-VISA, with the access through USBTMC and TCP/IP separately.

Steps:

1. Open MATLAB, and modify the current directory. In this demo, the current directory is modified to "D:\USBTMC_TCPIP_Demo".
2. Click File>>New>>Script in the Matlab interface to create an empty M file.
3. Coding:
 - a) USBTMC:

```
function USBTMC_test()  
  
% This code demonstrates sending synchronous read & write commands  
% to an USB Test & Measurement Class (USBTMC) instrument using  
% NI-VISA
```

%Create a VISA-USB object connected to a USB instrument

```
vu = visa('ni','USB0::0xF4ED::0xEE3A::sdg2000x::INSTR');
```

%Open the VISA object created

```
fopen(vu);
```

%Send the string "*IDN?", asking for the device's identification.

```
fprintf(vu, '*IDN?');
```

%Request the data

```
outputbuffer = fscanf(vu);
```

```
disp(outputbuffer);
```

%Close the VISA object

```
fclose(vu);
```

```
delete(vu);
```

```
clear vu;
```

```
end
```

Run result:

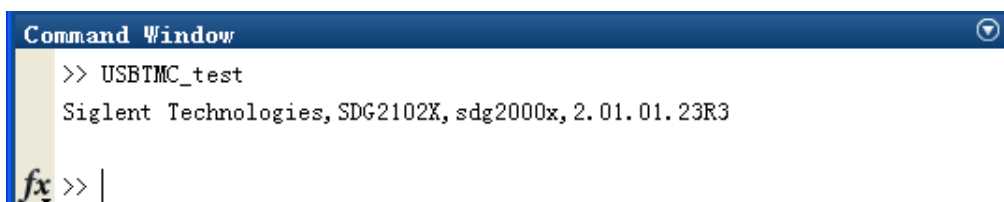

```
Command Window
>> USBTMC_test
Siglent Technologies, SDG2102X, sdg2000x, 2.01.01.23R3
fx >> |
```

b) TCP/IP:

Write a function TCP_IP_Test:

```
function TCP_IP_test()

% This code demonstrates sending synchronous read & write commands
% to a TCP/IP instrument using NI-VISA

%Create a VISA-TCPIP object connected to an instrument
%configured with IP address.

vt = visa('ni',['TCPIP0:','10.11.13.32', '::INSTR']);

%Open the VISA object created

fopen(vt);

%Send the string "*IDN?", asking for the device's identification.

fprintf(vt, '*IDN?');

%Request the data

outputbuffer = fscanf(vt);

disp(outputbuffer);

%Close the VISA object

fclose(vt);

delete(vt);

clear vt;

end
```

Run result:

```

Command Window
>> TCP_IP_test
Siglent Technologies, SDG2102X, sdg2000x, 2.01.01.23R3
fx >> |
    
```

4.1.2 LabVIEW Example

Environment: Windows 7 32-bit, LabVIEW 2011

Description: Query the instrument information using the “*IDN?” command over NI-VISA, with the access through USBTMC and TCP/IP separately.

Steps:

1. Open LabVIEW, and create a VI file.
2. Add controls. Right-click in the **Front Panel** interface, select and add **VISA resource name**, error in, error out and some indicators from the Controls column.
3. Open the **Block Diagram** interface. Right-click on the **VISA resource name**, select and add the following functions from VISA Palette from the pop-up menu: **VISA Write**, **VISA Read**, **VISA Open**, and **VISA Close**.
4. The connection is as shown in the figure below:

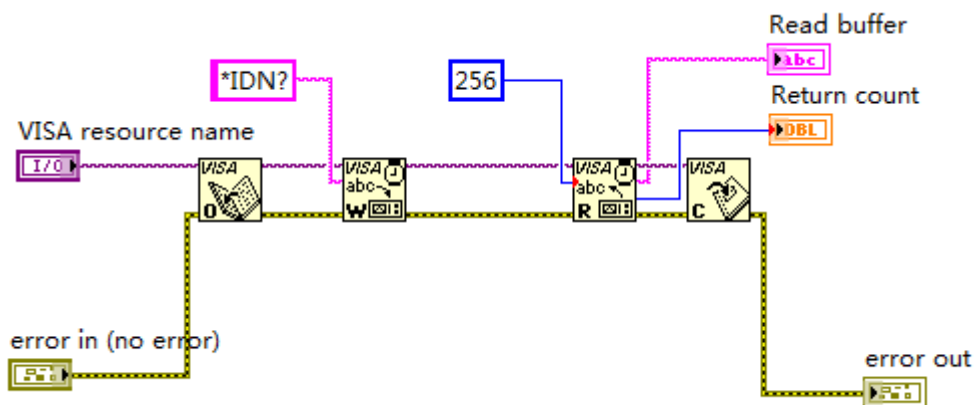

- Select the device resource from the VISA Resource Name list box and run the program.

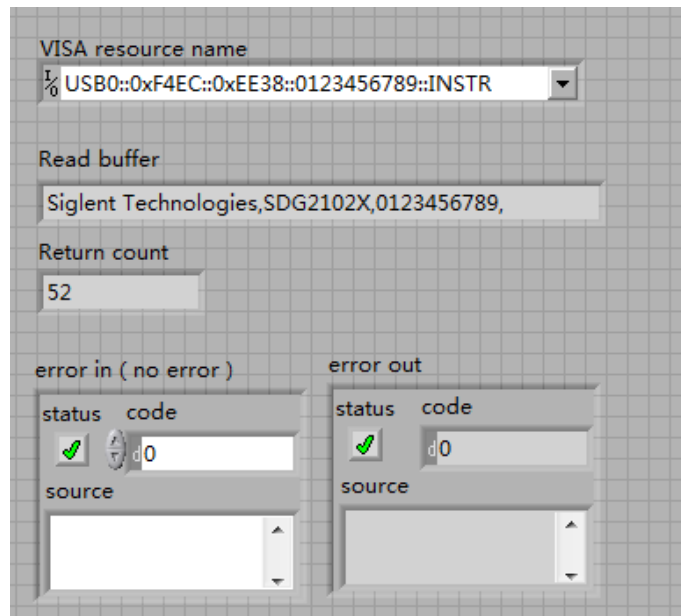

In this example, the VI opens a VISA session to a USBTMC device, writes a "*IDN?" command to the device, and reads back the response. After all communication is complete, the VI closes the VISA session.

- Communicating with the device via TCP/IP is similar to USBTMC. But you need to change VISA Write and VISA Read Function to Synchronous I/O. The LabVIEW default is asynchronous I/O. Right-click the node and select Synchronous I/O Mod>>Synchronous from the shortcut menu to write or read data synchronously.
- The connection is as shown in the figure below:

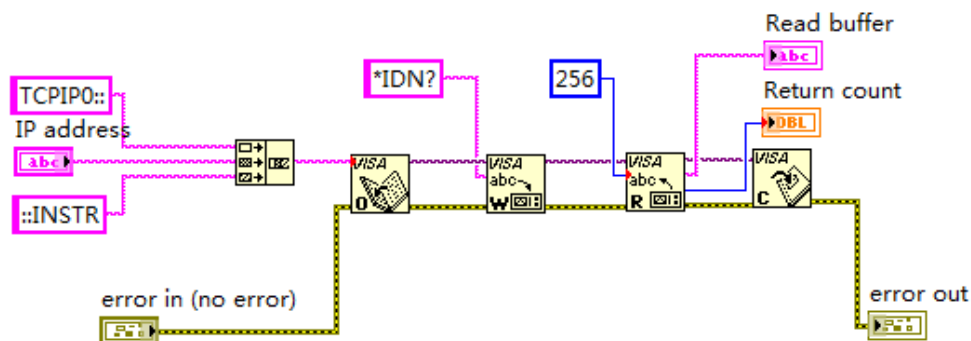

- Input the IP address and run the program.

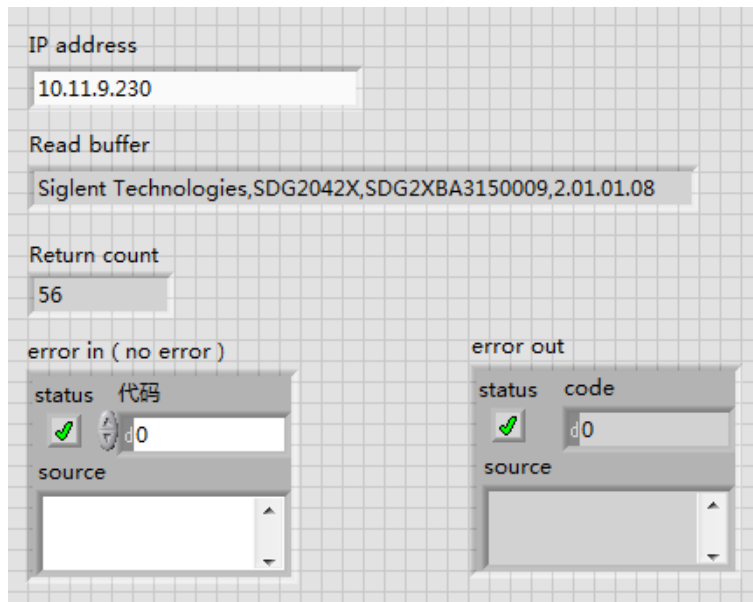

4.1.3 Python Example

Environment: Python2.7, PyVISA 1.4

(Please install PyVISA after installing Python2.7. Please refer to

<https://pyvisa.readthedocs.io/en/stable/getting.html> for the PyVISA installation guide.

Description: Use Python script to build an 8-point 16-bit arbitrary waveform (0x1000, 0x2000, 0x3000, 0x4000, 0x5000, 0x6000, 0x7000, 0x7fff) and save the waveform data in "wave1.bin", then download it to the instrument, finally read it back from the instrument and save it as "wave2.bin".

Below is the code of the script:

```
#!/usr/bin/env python2.7

# -*- coding: utf-8 -*-

import visa

import time

import binascii

#USB resource of Device

device_resource = "USB0::0xF4EC::0x1101::#15::INSTR"

#Little endian, 16-bit 2's complement

wave_points = [0x0010, 0x0020, 0x0030, 0x0040, 0x0050, 0x0060, 0x0070, 0xff7f]

def create_wave_file():

    """create a file"""

    f = open("wave1.bin", "wb")

    for a in wave_points:

        b = hex(a)
```

```
b = b[2:]

len_b = len(b)

if (0 == len_b):
    b = '0000'

elif (1 == len_b):
    b = '000' + b

elif (2 == len_b):
    b = '00' + b

elif (3 == len_b):
    b = '0' + b

c = binascii.a2b_hex(b)    #Hexadecimal integer to ASCII encoded string

f.write(c)

f.close()

def send_wave_data(dev):
    """send wave1.bin to the device"""
    f = open("wave1.bin", "rb")    #wave1.bin is the waveform to be sent
    data = f.read()
    print 'write bytes:',len(data)
    dev.write("C1:WVDT WVNM,wave1,FREQ,2000.0,AMPL,4.0,OFST,0.0,PHASE,0.0,WAVEDATA,%s" %
(data))    #"X" series (SDG1000X/SDG2000X/SDG6000X/X-E)
    dev.write("C1:ARWV NAME,wave1")
    f.close()

def get_wave_data(dev):
    """get wave from the device"""
    f = open("wave2.bin", "wb")    #save the waveform as wave2.bin
    dev.write("WVDT? user,wave1")    #"X" series (SDG1000X/SDG2000X/SDG6000X/X-E)
    time.sleep(1)
```

```

data = dev.read()

data_pos = data.find("WAVEDATA,") + len("WAVEDATA,")

print data[0:data_pos]

wave_data = data[data_pos:]

print 'read bytes:',len(wave_data)

f.write(wave_data)

f.close()

if __name__ == '__main__':

    """

    device = visa.instrument(device_resource, timeout=5000, chunk_size = 40*1024)

    create_wave_file()

    send_wave_data(device)

    get_wave_data(device)

```

Output waveform:

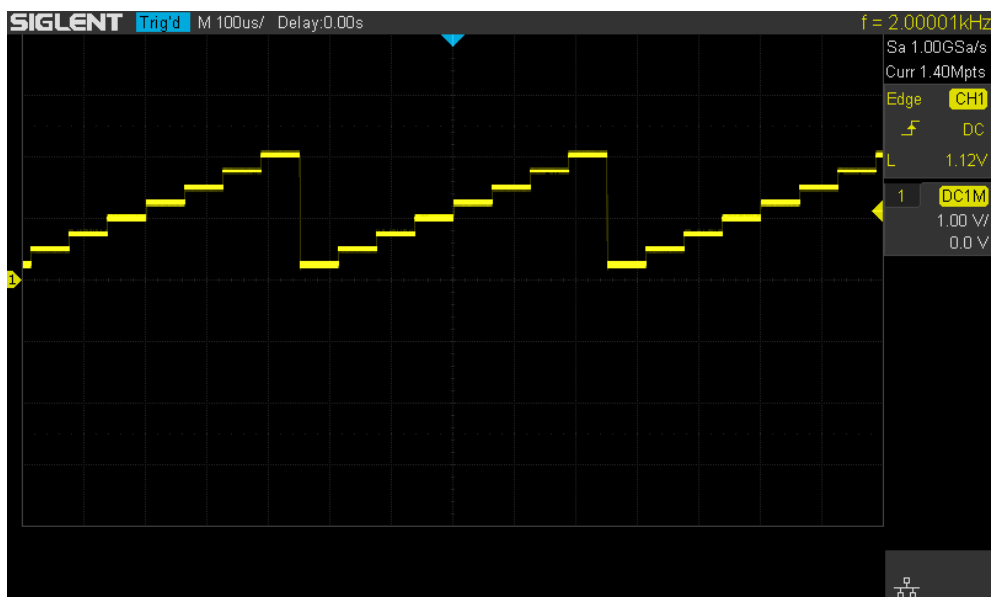

4.2 Examples of Using Sockets

4.2.1 Python Example

Python has a low-level networking module that provides access to the socket interface. Python scripts can be written for sockets to do a variety of tests and measurement tasks.

Environment: Windows 7 32-bit, Python v2.7.5

Description: Open a socket, send a query, and repeat this loop 10 times, finally close the socket. Note that SCPI command strings must be terminated with a “\n” (new line) character in programming.

Below is the code of the script:

```
#!/usr/bin/env python

#-*- coding:utf-8 -*-

#-----

# The short script is an example that opens a socket, sends a query,
# print the return message and closes the socket.

#-----

import socket # for sockets

import sys # for exit

import time # for sleep

#-----

remote_ip = "10.11.13.40" # should match the instrument's IP address

port = 5025 # the port number of the instrument service

count = 0
```

```
def SocketConnect():  
    try:  
        #create an AF_INET, STREAM socket (TCP)  
        s = socket.socket(socket.AF_INET, socket.SOCK_STREAM)  
  
    except socket.error:  
        print ('Failed to create socket.')        sys.exit();  
  
    try:  
        #Connect to remote server  
        s.connect((remote_ip , port))  
  
    except socket.error:  
        print ('failed to connect to ip ' + remote_ip)  
  
    return s
```

```
def SocketQuery(Sock, cmd):  
    try :  
        #Send cmd string  
        Sock.sendall(cmd)  
        time.sleep(1)  
  
    except socket.error:  
        #Send failed  
        print ('Send failed')        sys.exit()  
  
    reply = Sock.recv(4096)  
  
    return reply
```

```
def SocketClose(Sock):  
    #close the socket  
    Sock.close()
```

```
time.sleep(.300)

def main():

    global remote_ip

    global port

    global count

    # Body: send the SCPI commands "**IDN?" 10 times and print the return message

    s = SocketConnect()

    for i in range(10):

        qStr = SocketQuery(s, b"*IDN?\n")

        print (str(count) + ":: " + str(qStr))

        count = count + 1

    SocketClose(s)

    input('Press "Enter" to exit')

if __name__ == '__main__':

    proc = main()
```

Run result:

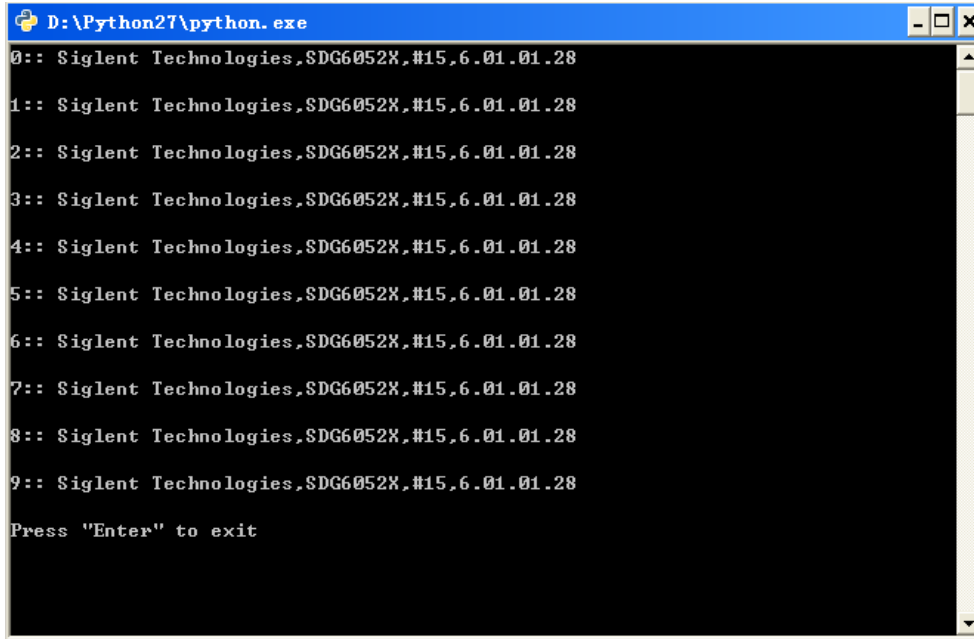

```
D:\Python27\python.exe
0:: Siglent Technologies,SDG6052X,#15.6.01.01.28
1:: Siglent Technologies,SDG6052X,#15.6.01.01.28
2:: Siglent Technologies,SDG6052X,#15.6.01.01.28
3:: Siglent Technologies,SDG6052X,#15.6.01.01.28
4:: Siglent Technologies,SDG6052X,#15.6.01.01.28
5:: Siglent Technologies,SDG6052X,#15.6.01.01.28
6:: Siglent Technologies,SDG6052X,#15.6.01.01.28
7:: Siglent Technologies,SDG6052X,#15.6.01.01.28
8:: Siglent Technologies,SDG6052X,#15.6.01.01.28
9:: Siglent Technologies,SDG6052X,#15.6.01.01.28
Press "Enter" to exit
```

5 Index

[*IDN](#)

[*OPC](#)

[*RST](#)

A

[ARWV ArbWaVe](#)

B

[BSWV BaSic WaVe](#)

[BTWV BursTWaVe](#)

[BUZZ BUZZer](#)

C

[CASCADE](#)

[CHDR Comm_HeaDeR](#)

[COUP COUPling](#)

[CMBN CoMBiNe](#)

F

[FCNT FreqCouNter](#)

H

[HARM HARMonic](#)

I

[IQ:CENT IQ:CENTerfreq](#)

[IQ:SAMP IQ:SAMPlerate](#)

[IQ:SYMB](#) [IQ:SYMBOLrate](#)

[IQ:AMPL](#) [IQ:AMPLitude](#)

[IQ:IQAD:GAIN](#) [IQ:IQADjustment:GAIN](#)

[IQ:IQAD:IOFFset](#) [IQ:IQADjustment:IOFFset](#)

[IQ:IQAD:QOFFset](#) [IQ:IQADjustment:QOFFset](#)

[IQ:IQAD:QSK](#) [IQ:IQADjustment:QSKew](#)

[IQ:TRIG:SOUR](#) [IQ:TRIGger:SOURce](#)

[IQ:WAVE:BUIL](#) [IQ:WAVEload:BUILtin](#)

[IQ:WAVE:USER](#) [IQ:WAVEload:USERstored](#)

[IQ:FrequencySampling](#) [IQ:FrequencySampling](#)

[IVNT](#) [INVERT](#)

L

[LAGG](#) [LAnGuaGe](#)

M

[MDWV](#) [MoDulateWaVe](#)

[MODE](#) [MODE](#)

N

[NBFM](#) [NumBer ForMat](#)

O

[OUTP](#) [OUTPut](#)

P

[PACP](#) [ParaCoPy](#)

R

[ROSC](#) [ROSCillator](#)

S

[SCFG](#) [Sys_CFG](#)

[SCSV](#) [SCreen SaVe](#)

[SWV](#) [SweepWaVe](#)

[SYNC](#) [SYNC](#)

[STL](#) [StoreList](#)

[SYST:COMM:LAN:IPAD](#) [SYSTem:COMMunicate:LAN:IPADdress](#)

[SYST:COMM:LAN:SMAS](#) [SYSTem:COMMunicate:LAN:SMASk](#)

[SYST:COMM:LAN:GAT](#) [SYSTem:COMMunicate:LAN:GATeway](#)

[SRATE](#) [SampleRATE](#)

W

[WVDT](#) [WVDT](#)

V

[VOLTPRT](#) [VOLTPRT](#)

[VKEY](#) [VirtualKEY](#)



About SIGLENT

SIGLENT is an international high-tech company, concentrating on R&D, sales, production and services of electronic test & measurement instruments.

SIGLENT first began developing digital oscilloscopes independently in 2002. After more than a decade of continuous development, SIGLENT has extended its product line to include digital oscilloscopes, isolated handheld oscilloscopes, function/arbitrary waveform generators, RF/MW signal generators, spectrum analyzers, vector network analyzers, digital multimeters, DC power supplies, electronic loads and other general purpose test instrumentation. Since its first oscilloscope was launched in 2005, SIGLENT has become the fastest growing manufacturer of digital oscilloscopes. We firmly believe that today SIGLENT is the best value in electronic test & measurement.

Headquarters:

SIGLENT Technologies Co., Ltd
Add: Bldg No.4 & No.5, Antongda Industrial
Zone, 3rd Liuxian Road, Bao'an District,
Shenzhen, 518101, China
Tel: + 86 755 3688 7876
Fax: + 86 755 3359 1582
Email: sales@siglent.com
Website: int.siglent.com

North America:

SIGLENT Technologies America, Inc
6557 Cochran Rd Solon, Ohio 44139
Tel: 440-398-5800
Toll Free: 877-515-5551
Fax: 440-399-1211
Email: info@siglentna.com
Website: www.siglentna.com

Europe:

SIGLENT Technologies Germany GmbH
Add: Staetzlinger Str. 70
86165 Augsburg, Germany
Tel: +49(0)-821-666 0 111 0
Fax: +49(0)-821-666 0 111 22
Email: info-eu@siglent.com
Website: www.siglenteu.com

Follow us on
Facebook: SiglentTech

